

# 2024

## INTERNATIONAL CATALOG



ITW Welding



# ITW WELDING SOLUTIONS

**BUILT BY PEOPLE LIKE YOU, FOR PEOPLE LIKE YOU**



**Careful planning. Attention to detail. Pride in a job well done.  
That's how people like you weld. That's how people at ITW work.**

ITW Welding offers a full portfolio solution to all welding needs, from welding equipment, PPE and filler metals to guns and torches. This portfolio includes four powerhouse brands: Miller, Hobart, Tregaskiss and Bernard.

ITW Welding designs and manufactures value-added equipment and specialty consumables with leading technology for a variety of industrial applications where weld quality is a critical factor: manufacturing, construction, aviation, agriculture, motorsports and more. Our customers demand quality, reliability and ease of use.

Whether you weld to build a project, a business or a dream, you can depend on ITW Welding products to get the job done right. Because we work the way you work.

## **WELDING DISTRIBUTORS KNOWLEDGE+ADVICE+SUPPORT**

When you work with a welding distributor, you're working with a valued partner. You can depend on their in-depth knowledge and assistance to select a perfect solution — and their support throughout your product's long lifetime of service. Visit [MillerWelds.com](http://MillerWelds.com) to find a welding distributor near you.

**Miller Electric Mfg. LLC**  
[MillerWelds.com](http://MillerWelds.com)

**Hobart Filler Metals**  
[HobartBrothers.com](http://HobartBrothers.com)

**Tregaskiss and Bernard**  
[Tregaskiss.com](http://Tregaskiss.com)



# NEW FROM BLUE

**4** Millermatic® 142



**70** Trailblazer® 330 Air Pak™



**66** Bobcat™ 230, 230 3 Phase (not shown), and 265



**73** Big Blue® 450 Duo CST™



**68** Trailblazer® 330 and 330 Diesel



**87** Digital Infinity™ Honor™ Welding Helmet







## Millermatic® 142 and 211

See literature DC/12.41 (142) and DC/12.58 (211)

**NEW!**



Millermatic 142

Millermatic 211



Millermatic 142 front panel



Millermatic 211 front panel

### Mild Steel Welding Capability

Max.	4.8 mm (3/16 in.)	9.5 mm (3/8 in.)
Model	142	211
Min.	0.6 mm (24 ga.)	0.6 mm (24 ga.)

### Aluminum Welding Capability

Max.	1.9 mm (14 ga.)	9.5 mm (3/8 in.)
Model	142	211
Min.	1.2 mm (18 ga.)	1.2 mm (18 ga.)

Aluminum welding with the Millermatic 142 or Millermatic 211 uses optional Spoolmate 100 spool gun with 4043 aluminum series wire OR optional Spoolmate 150 spool gun with 4000 or 5000 series aluminum wire.

**Recommended aluminum solution**  
Spoolmate 100 OR  
Spoolmate 150.



**Auto-Set™** automatically provides the right settings to weld mild steel while **infinite voltage control** allows the flexibility to manually set your own parameters.

- Set the wire diameter
- Set the thickness of material you are welding
- Start welding with the exact parameters you need!

**Inverter technology** combines best-in-class arc characteristics with the portability of a 15 kg (33 lb.) (142) or 17.2 kg (38 lb.) (211) machine. The arc is extremely forgiving to variations in arc length and travel speeds.

**Angled cast-aluminum drive system** with calibrated tension knob creates consistent feeding and easy setup.

**Quick Select™ drive roll** makes setup quicker by offering three grooves – two for different size solid wire and a third for flux-cored wire.

**Auto Spool Gun Detect™** automatically detects when a MIG gun or spool gun is connected, eliminating the need for a switch.

**Smooth-Start™** provides a smooth, spatter-free start.

**Fan-On-Demand™** cooling system only operates when needed, reducing power consumption and keeping internal components cleaner.

**Thermal overload protection** shuts down unit if airflow is blocked or duty cycle is exceeded. Automatically resets when unit cools.

**Uses 102 or 203 mm (4 or 8 in.) spools.**

### Millermatic 211 model additional features

**Advanced Auto-Set™** includes five different wire/gas combinations.



**Multi-voltage plug (MVP™)** allows for connection to 120- or 240-volt receptacles without tools. Choose the plug that fits the receptacle and connect it to the power cord.

Light industrial ● **CV DC** 1 Phase

### Processes

- MIG (GMAW) • Flux-cored (FCAW)

### Comes complete with

- 3 m (10 ft.) 100-amp MDX™-100 MIG gun
- 3 m (10 ft.) work cable with clamp
- 2 m (6.5 ft.) power cord with plug (Millermatic 142) **OR** 2 m (6.5 ft.) power cord with MVP plugs for 120 V and 240 V (Millermatic 211)
- Quick Select™ drive roll for 0.6 mm (.024 in.) or 0.8/0.9 mm (.030/.035 in.) solid wire, and 0.8/0.9 mm (.030/.035 in.) flux-cored wire

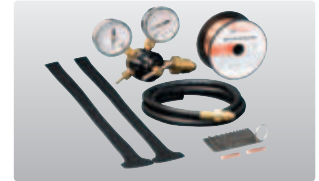

- Flow gauge regulator and gas hose for argon or AR/CO<sub>2</sub> mix, two 0.8 mm (.030 in.) contact tips, Hobart® spool of 0.8 mm (.030 in.) solid wire, hook-and-loop cord wraps and material thickness gauge (229895)

### Most popular accessories

- Spoolmate™ 100 300371
- Spoolmate™ 150 301272



- **Running Gear/Cylinder Rack** 301239
- Protective Cover 301737 For Millermatic 142 301262 For Millermatic 211
- V-Knurled Drive Roll 202926

Model/Stock Number	Input Power	Amperage Range	Rated Output	Amps Input at Rated Output, 50/60 Hz		Wire Feed Speed	Wire Type and Diameter Capacity	Power Source Dimensions	Power Source Net Weight
				120 V	240 V	KVA	KW		
Millermatic 142 907838	120 V	30-140	100 A at 19 VDC, 60% duty cycle	19.3	–	2.32	2.32	H: 372 mm (14.625 in.) W: 248 mm (9.75 in.) D: 508 mm (20 in.)	15.4 kg (33 lb.)
			80 A at 18 VDC, 100% duty cycle	14.8	–	1.78	1.78		
Millermatic 211 907614	120 V	30-130	115 A at 19.8 VDC, 20% duty cycle	24.3	–	2.9	2.9	H: 318 mm (12.5 in.) W: 286 mm (11.25 in.) D: 521 mm (20.5 in.)	17.2 kg (38 lb.)
	240 V		150 A at 21.5 VDC, 40% duty cycle	–	16.6	4.0	4.0		





# Millermatic® 252

See literature DC/12.49

Industrial ● **CV DC 1**  
Phase

**Processes**

- MIG (GMAW) ▪ Flux-cored (FCAW)

**Comes complete with**

- 4.5 m (15 ft.), 250-amp MDX™-250 MIG gun with AccuLock™ MDX™ consumables
- 3 m (10 ft.) work cable with clamp
- 3 m (10 ft.) industrial power cord (and plug on 208/240 V model)
- Factory-installed gas solenoid
- Flow gauge regulator and gas hose for argon or AR/CO<sub>2</sub> mix
- Factory-installed lowered running gear/cylinder rack with chain to secure gas cylinder
- 0.8/0.9 mm (.030/.035 in.) reversible dual-groove drive rolls
- Extra contact tips

**Most popular accessories**

- Spoolmate™ 200 Spool Gun
- Spoolmatic® Spool Gun (non-Pro gun only)
- Dual EZ-Change™ Low Cylinder Rack 300337
- Elevated Gun and Cable Rack 300335
- Protective Cover 195142
- 230-Volt Extension Cord 770644

**Welding Capability**

Max. 13 mm (1/2 in.)	Max. 9.5 mm (3/8 in.)
<b>Mild Steel</b>	<b>Aluminum</b>
Min. 0.8 mm (22 ga.)	Min. 1.9 mm (14 ga.)

Aluminum welding uses optional Spoolmatic spool gun.



Recommended aluminum solution Spoolmatic

**Infinite voltage control with self-calibrating digital meters** that permit presetting of voltage and wire feed speed. Ensures precise parameters and accuracy.

**EXCLUSIVE! Auto-Gun Detect™** automatically adjusts voltage, wire speed and timers for faster switching between MIG, push-pull and spool guns.

**Integrated digital timers** come complete with presettable preflow/postflow, burnback, spot and delay (stitch) timers. Independent timers for MIG and spool gun.

**Superior aluminum MIG welding with direct connection** of optional Spoolmate™ 200 and Spoolmatic® spool guns. No extra module to buy or install.

**Heavy-duty aluminum two-drive-roll system.**

**Uses 102, 203 or 305 mm (4-, 8- or 12-inch) spools.**

**Fan-On-Demand™** cooling system only operates when needed, reducing power consumption and keeping internal components cleaner.

\*While idling.

Stock Number	Amperage Range	Rated Output	Amps Input at Rated Output, 60 Hz					KVA	KW	Wire Feed Speed	Wire Type and Diameter Capacity	Dimensions	Net Weight
			208 V	230 V	240 V	460 V	575 V						
907321 208/240 V	30-300	200 A at 24 VDC, 60% duty cycle	57.0	—	50.8	—	—	11.4	7.1	1.3-17.8 m/min. (50-700 ipm)	Solid steel 0.6-1.2 mm (.023-.045 in.) Stainless 0.6-1.2 mm (.023-.045 in.) Flux-cored 0.8-1.2 mm (.030-.045 in.)	H: 762 mm (30 in.) W: 483 mm (19 in.) D: 1,016 mm (40 in.)	93 kg (205 lb.)
		250 A at 26.5 VDC, 40% duty cycle	64.2	—	56.4	—	—	12.6	9.4				
907322 230/460/575 V		200 A at 24 VDC, 60% duty cycle	—	46	—	23	18	9.8	7.5				
		250 A at 26.5 VDC, 40% duty cycle	—	2*	—	1*	0.8*	0.46*	0.13*				

FABCO® TRIPLE 7

# EXPANDED

PROPERTIES. EXPANDED POSSIBILITIES.

**FabCO® Triple 7 (FCAW-G)**

- Upgraded & relaunched product
- Premium weldability in all positions
- Gas & application versatility
- D1.8 approved for seismic applications
- Ideal for all skill levels

**FabCOR® EDGE™ XP**

X-CEPTIONAL PERFORMANCE AND PRODUCTIVITY.

**FabCOR® Edge™ XP**

- Next generation of FabCOR® Edge™ metal-cored wire
- Boosts productivity
- Balanced arc characteristics
- Best-in-class silicon gathering
- Exceptional wetting action over mill scale



Visit [HobartBrothers.com](http://HobartBrothers.com) for more information.



## Millermatic® 255

See literature DC/12.8



Millermatic 255 with running gear package shown.

### Welding Capability

Max. 13 mm (1/2 in.)	Max. 13 mm (1/2 in.)
Mild Steel	Aluminum
Min. 0.6 mm (24 ga.)	Min. 1.2 mm (18 ga.)

Aluminum welding uses optional XR-Aluma-Pro push-pull gun.

### Recommended aluminum solution

XR-Aluma-Pro™ push-pull gun



**Easy-to-understand interface with 7-inch color LCD display** ensures proper machine setup and parameter selection, reducing setup time and increasing weld time.

- Quick-access Auto-Set and pulse mode backlit buttons across the top illuminate when active
- Soft-key buttons below the display change function depending on which screen is displayed – makes setup or change quick, easy and intuitive
- Large text for easier readability
- Intuitive connection setup images
- Full troubleshooting descriptions versus help errors and look up codes



Allows for any input voltage hookup (208–240 V, single-phase) with no manual linking, providing convenience in any job setting. Ideal solution for dirty or unreliable power.

**Built-in pulsed MIG programs.** All programmed information is restored after each power up – steel/stainless steel/aluminum/silicon bronze.

**Auto-Set™ Elite** offers predefined weld settings to increase ease of use and ensure that the job is done right for operators of all skill levels.

- Available for MIG and pulsed MIG processes with the ability to fine-tune your settings
- Set weld parameters by selecting wire and gas type, wire diameter and material thickness

**Program mode** allows easy save and recall of favorite weld settings. Delivers greater productivity and consistent quality while minimizing supervisor intervention.

**EXCLUSIVE! Auto-Gun Detect™** automatically adjusts voltage, wire speed and timers for faster switching between MIG, push-pull and spool guns.

**Heavy-duty aluminum two-drive-roll system.**

**Uses 102, 203 or 305 mm (4-, 8- or 12-inch) spools.**

**Fan-On-Demand™** cooling system only operates when needed, reducing power consumption and keeping internal components cleaner.

Industrial ● CV DC 1 Phase

### Processes

- MIG (GMAW) • Flux-cored (FCAW)
- Pulsed MIG (GMAW-P)

### Comes complete with

- 4.5 m (15 ft.) 250-amp MDX™-250 MIG gun with AccuLock™ S consumables
- 3 m (10 ft.) industrial power cord
- Factory-installed gas solenoid
- Flow gauge regulator and gas hose for argon or AR/CO<sub>2</sub> mix
- .035/.045 in. reversible V-groove drive rolls
- Extra contact tips and material thickness gauge (229895)

### Most popular accessories

- Spoolmatic® Spool Gun (non-Pro gun only)
- XR-Aluma-Pro™ Air-Cooled Push-Pull Guns
- XR™-Pistol-Pro Air-Cooled Push-Pull Guns
- EZ-Latch™ Single Cylinder Running Gear 301449
- EZ-Latch™ Dual Cylinder Rack with Elevated Gun and Cable Rack 301481
- Protective Cover 301521

Stock Number 907734	Amperage Range	Rated Output	Amps Input at Rated Output, 50/60 Hz				Wire Feed Speed	Wire Type and Diameter Capacity		Power Source Dimensions	Power Source Net Weight
	20-350	230 A at 25.5 VDC, 60% duty cycle	208 V	240 V	KVA	KW		Solid steel	0.6-1.2 mm (.023-.045 in.)		
								Stainless	0.6-1.2 mm (.023-.045 in.)	H: 489 mm (19.24 in.)	38 kg (84 lb.)
								Aluminum	0.9-1.2 mm (.035-.047 in.)	W: 349 mm (13.75 in.)	
								Flux-cored	0.8-1.2 mm (.030-.045 in.)	D: 616 mm (24.25 in.)	
								Silicon bronze	0.8-0.9 mm (.030-.035 in.)		



# Millermatic® 355

See literature DC/12.95

Industrial ● CV DC 3 1  
Phase Phase



Millermatic 355 with MIG gun package shown (ALL packages include running gear).

### Welding Capability

Max. 13 mm (1/2 in.)	Max. 13 mm (1/2 in.)
Mild Steel	Aluminum
Min. 0.8 mm (22 ga.)	Min. 1.2 mm (18 ga.)

Aluminum welding uses optional XR-Aluma-Pro push-pull gun.

### Recommended aluminum solution

XR-Aluma-Pro™ push-pull gun.



**Easy-to-understand interface with 178 mm (7 in.) color LCD display** ensures proper machine setup and parameter selection, reducing setup time and increasing weld time.

- Quick-access Auto-Set and pulse mode backlit buttons across the top illuminate when active
- Soft-key buttons below the display change function depending on which screen is displayed – makes setup or change quick, easy and intuitive
- Large text for easier readability
- Intuitive connection setup images
- Full troubleshooting descriptions versus help errors and look up codes

**Single- or three-phase input power** provides versatility to utilize any North American power (208, 240, 460, 575 V).

**Input voltage selection switch** located in the wire drive compartment provides the ability to manually switch input voltage.

**Built-in pulsed MIG programs.** All programmed information is restored after each power up – steel/stainless steel/aluminum/metal core/silicon bronze.

**Auto-Set™ Elite** offers predefined weld settings to increase ease of use and ensure that the job is done right for operators of all skill levels.

- Available for MIG and pulsed MIG processes with the ability to fine-tune your settings
- Set weld parameters by selecting wire and gas type, wire diameter and material thickness

**Program mode** allows easy save and recall of favorite weld settings. Delivers greater productivity and consistent quality while minimizing supervisor intervention.

**Trigger program select** increases productivity by eliminating the need to go back to machine to change weld settings. Simply tap gun trigger to select the program.

**EXCLUSIVE! Auto-Gun Detect™** automatically adjusts voltage, wire speed and timers for faster switching between MIG, push-pull and spool guns.

**Heavy-duty aluminum four-drive-roll system.**

**Uses 102, 203 or 305 mm (4-, 8- or 12-inch) spools.**

**Fan-On-Demand™** cooling system only operates when needed, reducing power consumption and keeping internal components cleaner.

**Optional demo cable kit** (sold separately) powers the display through USB to train users in a quiet conference room or showroom versus connecting to shop power in a noisy work environment.

### Processes

- MIG (GMAW) ▪ Flux-cored (FCAW)
- Pulsed MIG (GMAW-P)

### Comes complete with

- 4.5 m (15 ft.) 300-amp Bernard® BTB MIG gun with AccuLock™ S consumables and reversible V-groove drive rolls for 0.9/1.2 mm (.035/.045 in.) wire
- **OR** 7.6 m (25 ft.) XR-Aluma-Pro™ air-cooled push-pull MIG gun with Miller® FasTip™ consumables and reversible U-grooved drive rolls for 0.9 and 1.2 mm (.035 and .047 in.) aluminum wire
- EZ-Latch™ single cylinder running gear
- 3 m (10 ft.) work cable with clamp
- 2.7 m (9 ft.) industrial power cord
- Factory-installed gas solenoid
- Flow gauge regulator and gas hose for argon or AR/CO<sub>2</sub> mix
- Chain to secure gas cylinder
- Extra contact tips and material thickness gauge (229895)

### Most popular accessories

- MDX™-250 EZ-Select™ MIG Gun 1770047
- Bernard® MIG Guns
- Spoolmate™ 200 Spool Gun
- Spoolmatic® Spool Gun (non-Pro gun only)
- XR-Aluma-Pro™ Air-Cooled Push-Pull Guns
- XR™-Pistol-Pro Air-Cooled Push-Pull Guns



- **EZ-Latch™ Dual Cylinder Rack with Elevated Gun and Cable Rack** 301481

Converts an EZ-Latch Single Cylinder Running Gear into a Dual Cylinder Rack Running Gear



- **Demo Cable Kit** 289696

\*See literature DC/12.95 for dimensions and weight with running gear.

Stock Number (907808) 208/240/460/575 V	Input Power	Amp/Volt Ranges	Rated Output	Amps Input at Rated Output, 50/60 Hz 208 V 240 V 460 V 575 V KVA KW	Max. Open-Circuit Voltage	Wire Feed Speed	Wire Type and Diameter Capacity	Power Source Dimensions*	Power Source Net Weight*
	Three-phase	20-400 A 12-34 V	310 A at 29.5 VDC, 60% duty cycle	32.3 28.8 18.2 15.4 15.3 11.5	90 VDC	1.3-20 m/min. (50-800 ipm)	<b>Solid steel</b> 0.9-1.2 mm (.035-.045 in.)	H: 489 mm (19.25 in.) W: 349 mm (13.75 in.) D: 667 mm (26.25 in.)	45 kg (99 lb.)
	Single-phase, 460 or 575 V	20-400 A 12-34 V	– – 35.6 32.3 15.0 11.1	<b>Stainless</b> 0.6-1.2 mm (.023-.045 in.)					
	Single-phase, 208 or 240 V	20-350 A 12-32 V	69.6 62.5 – – 15.0 11.1	<b>Aluminum</b> 0.9-1.2 mm (.035-.047 in.)					
							<b>Flux-cored</b> 0.9-1.2 mm (.035-.045 in.)		
							<b>Metal-core</b> 1.2-1.3 mm (.045-.052 in.)		
							<b>Silicon bronze</b> 0.8-0.9 mm (.030-.035 in.)		





# AlumaFeed® Synergic Aluminum Welding System

See literature DC/34.0

Dedicated aluminum system for the most advanced MIG and synergic pulsed MIG performance.



AlumaPower™ 350 MPa and XR-AlumaFeed® SuitCase® with XR-Aluma-Pro gun air-cooled shown.



AlumaPower™ 350 model allows for any input voltage hookup (208–575 V, single- or three-phase) with no manual linking, providing convenience in any job setting. Ideal solution for dirty or unreliable power. 450 model is 230/460 V manual link or 575 V, three-phase only.

**Impact-resistant and flame-retardant suitcase-style feeder.**

**Synchronized, true push-pull wire feed system** for precise wire feeding and arc performance.

**Profile Pulse™** provides TIG appearance with MIG simplicity and productivity. Achieve “stacked dimes” without gun manipulation. Profile Pulse frequency can be changed to increase or decrease the spacing between the ripple pattern to achieve the desired weld appearance.



**Synergic pulsed MIG.** As wire speed increases/decreases, pulse parameters also increase/decrease to match the right amount of power needed, eliminating the need to make additional adjustments.

**Built-in MIG and pulsed MIG programs** automatically set the optimal parameters for a wide variety of wires making it easy to set up and use.

**Parameter and system locks** enhance quality assurance and protect weld consistency.

**Trigger schedule select** allows operator to change between two sets of weld parameters.

Heavy Industrial **CV DC 3 1** AlumaPower 450  
Phase Phase is 3-phase only.

### Processes

- Aluminum MIG (GMAW)
- Aluminum pulsed MIG (GMAW-P)

### Most popular accessories

- XR™ Push-Pull Guns
- MIGRunner™ Cart 195445
- Coolmate™ 3 043007
- Coolant 043810
- Industrial MIG 4/0 Kits
  - 300405 With Dinse connectors (350 MPa only)
  - 300390 With lug connectors (450 MPa only)
- Consists of flowmeter regulator with 3 m (10 ft.) gas hose, 3 m (10 ft.) 4/0 feeder weld cable, and 4.6 m (15 ft.) work cable with 600-amp C-clamp
- Extension Cables
  - 247831025 7.6 m (25 ft.)
  - 247831050 15 m (50 ft.)
  - 247831080 24.4 m (80 ft.)
- 1.6 mm (1/16 in.) Liner and Wire Kit for Gun 230708
- 1.6 mm (1/16 in.) Drive Roll Kit for Control Box 195591
- For gun and feeder remote options, see literature DC/34.0 or visit MillerWelds.com

## Models

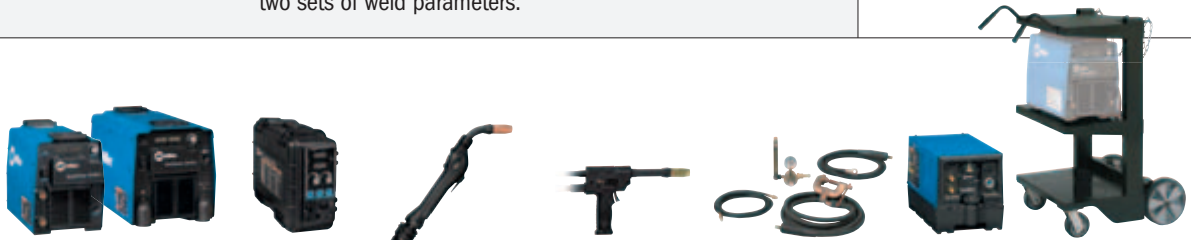

Power Source Only Stock Number		XR-AlumaFeed SuitCase Feeder	XR-Aluma-Pro™ Push-Pull MIG Gun	XR™-Pistol Grip Push-Pull MIG Gun	Industrial MIG 4/0 Kit	Coolmate™ with Coolant	Cart
AlumaPower 350 MPa (907420) 208–575 V (907420001) 208–575 V with auxiliary power	(301593), CE	(301567)	7.6 m (25 ft.) air-cooled	–	–	–	–
	(301593), CE	(301567)	–	9 m (30 ft.) air-cooled	–	–	–
	(301593), CE	(301567)	7.6 m (25 ft.) air-cooled	–	With Dinse connectors	–	MIGRunner cart
AlumaPower 450 MPa (907483) 230/460 V w/auxiliary power (907484) 575 V w/auxiliary power	(301593), CE	(301567)	7.6 m (25 ft.) air-cooled	–	With lug connectors	–	MIGRunner cart
	(301593), CE	(301567)	25 ft. water-cooled	–	With lug connectors	Coolmate 3	MIGRunner cart

Model	Input Power	Amp/Volt Ranges	Rated Output	Amps Input at Rated Load Output, 60 Hz					KVA	KW	Max. Open-Circuit Voltage	Dimensions	Net Weight
				208 V	230 V	400 V	460 V	575 V					
AlumaPower 350 MPa	3-phase	5–425 A 10–38 V	350 A at 34 VDC, 60% duty cycle	40.4	36.1	20.6	17.8	14.1	14.2	13.6	75 VDC	H: 432 mm (17 in.) W: 318 mm (12.5 in.) D: 610 mm (24 in.)	36.3 kg (80 lb.)
	1-phase	5–425 A 10–38 V	300 A at 32 VDC, 60% duty cycle	60.8	54.6	29.7	24.5	19.9	11.7	11.2			
AlumaPower 450 MPa	3-phase	15–600 A 10–38 V	450 A at 36.5 VDC, 100% duty cycle	–	49.4	–	27.2	23.6	21.6 (23.5 on 575 V)	18.3	90 VDC	H: 438 mm (17.25 in.) W: 368 mm (14.5 in.) D: 689 mm (27.125 in.)	55.3 kg (122 lb.)

XR-AlumaFeed SuitCase Feeder	Input Power	Input Welding Circuit Rating	Wire Feed Speed	Wire Diameter Capacity	Maximum Spool Size Capacity	Dimensions	Net Weight
14-pin compliant, but only operates synergically w/MPa power sources	24 VAC, 5 A, 50/60 Hz	400 A at 100% duty cycle System duty cycle is limited to gun rating	1.3–23 m/min. (50–900 ipm)	0.9–1.6 mm (.035–1/16 in.) Requires wire kit (230708) for gun and drive roll kit (268850) for control box to run 1.6 mm (1/16 in.) wire	305 mm (12 in.)	H: 394 mm (15.5 in.) W: 229 mm (9 in.) D: 533 mm (21 in.)	14.1 kg (31 lb.)



# Deltaweld® Systems See literature DC/16.5

The new standard in manufacturing provides the solution for welders of all skill levels, plus pulsed MIG capabilities with Intelx™ Pro integrated systems.

*Deltaweld 350 System  
MIGRunner with single-wire  
Intelx Pro feeder shown.*

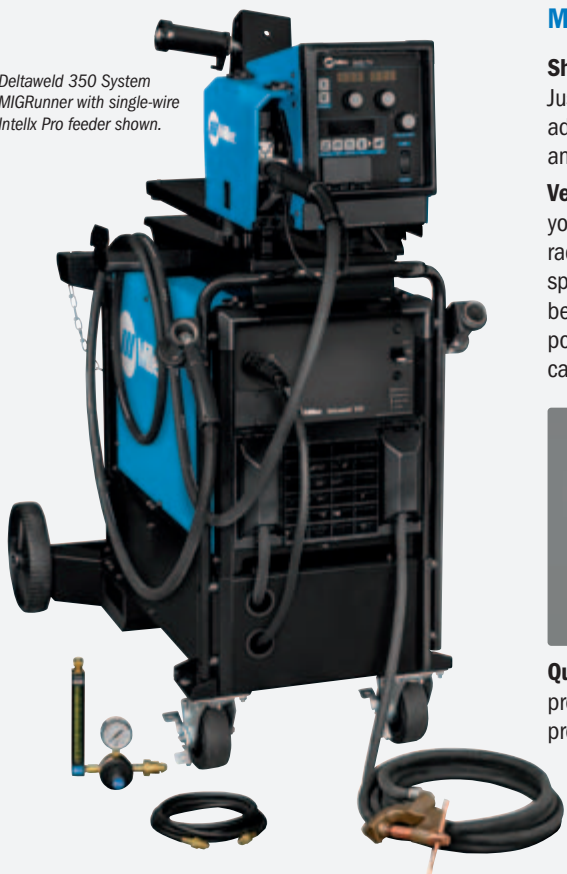

**Reduce the time and hassle of setting up welding systems. Make your move to a weld-ready Deltaweld MIGRunner™.**

**Ships as a complete package.**

Just hook up your primary power, add gas, wire and welding gun, and you're ready to weld.

**Versatile MIGRunner cart** keeps you organized with its dual cylinder rack, MIG gun holders and spacious storage compartment beneath the power source, and portable with its lockable front casters and oversized rear wheels.

**Old Deltaweld® System**



Time spent assembling old Deltaweld package

**New Deltaweld® System**



Time spent assembling new Deltaweld package



**Quality-engineered cable management** protects your connections to keep you productive.



**Single-wire feeder swivels** for convenience and function, eliminating wear on gun and liner assembly. It moves with the MIG gun, allowing operator to see the front of the feeder and which parameters are selected.

## Deltaweld® Power Sources

**Two power source choices**

- **Deltaweld 350** has auxiliary power standard and optional 14-pin receptacle and meters for use with legacy feeders.
- **Deltaweld 500** has auxiliary power and meters standard and an optional 14-pin receptacle. It adds more power (500 amps at 100 percent duty cycle) and a dedicated gouge mode for up to 9.5 mm (3/8 in.) carbons.

**ArcConnect™** is a next generation communication that utilizes high-speed signals to improve weld performance and allow point-of-use controls to be located at the feeder.

**Wind Tunnel Technology™** Internal air flow that protects components, greatly improving reliability.

**Fan-On-Demand™** cooling system only operates when needed, reducing power consumption and keeping internal components cleaner.

**Welding Intelligence™** Get more done, produce higher-quality welds and control costs with Insight Core (factory-installed option on select models). Gives owners/managers visibility of welder productivity, so they can make informed decisions to drive improvements.



Deltaweld 350

Deltaweld 500



# Intellex™ Wire Feeders

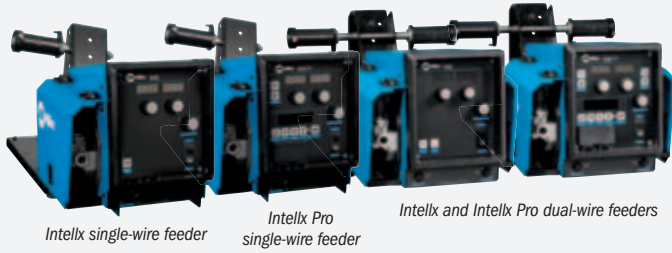

### Intellex Feeder Features

Feature	Basic	Pro	Elite
Digital meters	●	●	Color LCD
Remote voltage	●	●	●
Wire feed speed	●	●	●
Arc control	●	●	●
Trigger hold	●	●	●
Wire jog and purge	●	●	●
Wire feed speed feedback	●	●	●
Four drive rolls	●	●	●
Rotatable drive	●	●	●
Up to 60 lb. spool	●	●	●
Dual-wire models	●	●	●
MIG process	●	●	●
EZ-Set MIG and Accu-Pulse®		●	●
Trigger select		●	●
Preflow and postflow		●	●
Memory slots		2	8
Out-of-box programs (steel/stainless)		●	●
Out-of-box programs (aluminum/nickel/copper nickel/bronze/titanium)			●
EZ-Set HD MIG and RMD®			●
XR™ Plus push-pull gun compatible			●
Profile Pulse™			●
Weld sequence control			●
Trigger dual schedule			●
Dual schedule switch support			●
Parameter limits, memory lockouts and system lock			●
Wire retract, auto thread and auto purge			●

### Dedicated wire feeder options

- **Intellex™ feeders** with arc control feature means welders can produce better welds with minimal parameter adjustments.
- **Intellex™ Pro feeders** add Accu-Pulse®, EZ-Set, steel weld programs, and memory buttons. Accu-Pulse® provides a 28 percent wider operating window and a more forgiving arc, while EZ-Set simplifies parameter setup based on material thickness, removing complexity.

**Dual-wire models** allow two different wire types to be available on one feeder, avoiding downtime from changing spools and drive rolls.

**User-friendly interface** makes the system easy to set up and adjust with minimal training.

**Rotatable drive assembly** allows operator to rotate the drive, eliminating severe bends in the wire feed path. This extends gun-liner life and aids in feeding difficult wires.

**Balanced-pressure drive-roll design and tensioners** feed wire in its truest and straightest form for consistent feedability and better welding performance.

### Processes

- MIG (GMAW) = Flux-cored (FCAW)
- Accu-Pulse® MIG (GMAW-P) with Intellex Pro feeder
- Air carbon arc gouging (CAC-A) with Deltaweld 500

### MIGRunner™ packages include

- Deltaweld power source 350: 907747 500: 907785 or 907786
- Intellex **OR** Intellex Pro single-wire or dual-wire feeder
- Bernard® BTB Gun(s) (350: 300 A **OR** 500: 400 A) and 0.9/1.2 mm (.035/.045 in.) V-groove drive rolls
- Factory-installed Deltaweld running gear with cable holder, gun holders, and chains for gas cylinders
- Cart accessory kit consisting of flowmeter regulator(s) with 1.5 m (5 ft.) gas hose(s), 3 m (10 ft.) 4/0 feeder weld cable with lugs, 4.6 m (15 ft.) work cable with 600-amp C-clamp, and 2.7 m (9 ft.) ArcConnect cable
- Quick-setup guide and video

### Most popular accessories

- Bernard® MIG Guns
  - Deltaweld 350/500 Running Gear 301523
  - Industrial MIG 4/0 Kits with lugs (stationary packages only)
  - ArcConnect Control/Motor Cables 280471009 2.7 m (9 ft.) 280471015 4.6 m (15 ft.) 280471025 7.6 m (25 ft.) 280471050 15.2 m (50 ft.) 280471075 22.9 m (75 ft.) 280471100 30.5 m (100 ft.)
  - Cart Accessory Kit 301528 (see above for contents)
- Note: For dual-wire feeder kit both 301528 and 301579 are required.*
- Feeder Swivel Kit 301533 Mounts single- or dual-wire feeder to Deltaweld – only single feeder swivels
  - Stationary Handle Kit 301529
  - Hanging Bail 058435
  - Pipe Post with 457 mm (18 in.) Base 149838 1.2 m (4 ft.) 149839 1.8 m (6 ft.)
  - Swingpak™ Base 183997
  - Single/Dual Spool Carrier 300353 For 1.2 m (4 ft.) post 300352 For 1.8 m (6 ft.) post

# Intellex™ Pro Swingarc™

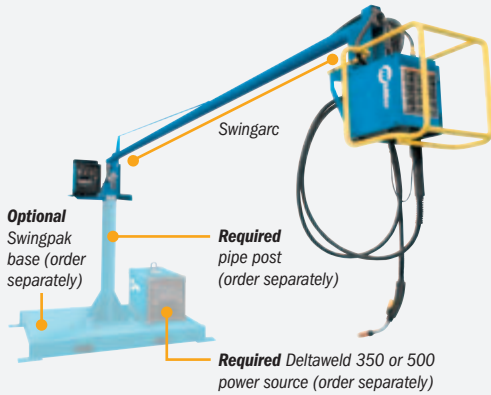

**Single- and dual-wire models with 3.7 or 4.9 m (12 or 16 ft.) booms** are sized to accommodate a variety of weld cell layouts (7.3 or 9.8 m [24 or 32 ft.] diameter work area).

**Counterbalance design** makes it easy to position boom and **360-degree rotation and 60-degree lift angle** maximize work area.

**In-boom cable routing** organizes hoses and cables for a cleaner work environment.

Intellex Pro Swingarc 3.7 m (12 ft.) Single	Intellex Pro Swingarc 3.7 m (12 ft.) Dual	Intellex Pro Swingarc 4.9 m (16 ft.) Single
(301556) Boom	(301557) Boom	(301558) Boom
(301552) ROI	(301553) ROI	(301552) ROI
(301554) Wire Drive	(301555) Wire Drive	(301554) Wire Drive

350 A	Power Source Only/Stock Number Most Popular Models ◀	Amp/Volt Ranges	Rated Output	Amps Input at Rated Load Output, 60 Hz					Power Source Dimensions (Includes lift eye)	Power Source Net Weight	
				208 V	230 V	460 V	575 V	KVA	KW		
	<b>Deltaweld 350</b> (907747) ◀ 208/230/460 V, 60 Hz (907747001) 208/230/460 V with 14-pin and meters (907747002) 208/230/460 V with Insight Core (907853001) 400 V with 14-pin, CE (907853003) 400 V with 14-pin and Insight Core, CE	20-400 A 10-38 V	300 A at 29 VDC, 100% duty cycle 350 A at 31.5 VDC, 60% duty cycle 425 A at 35.25 VDC, 30% duty cycle	29.3	26.5	14.6	–	11.6	10.0	H: 568 mm (22.36 in.) W: 390 mm (15.35 in.) D: 740 mm (29.15 in.)	52.2 kg (115 lb.)
	<b>Deltaweld 500</b> (907785) ◀ 208/230/460 V, 60 Hz with meters (907785001) 208/230/460 V with 14-pin and meters (907785002) 208/230/460 V w/meters and Insight Core (907854001) 400 V with 14-pin, CE (907854003) 400 V with 14-pin and Insight Core, CE	30-650 A 10-44 V	500 A at 39 VDC, 100% duty cycle 575 A at 42.75 VDC, 60% duty cycle 650 A at 44 VDC, 25% duty cycle	64.2	58.1	30.4	24.8	24.2	21.7	H: 568 mm (22.36 in.) W: 390 mm (15.35 in.) D: 804 mm (31.65 in.)	65.8 kg (145 lb.)

Feeder Only/Stock Number	Input Power	Input Welding Circuit Rating	Wire Feed Speed	Wire Diameter Capacity	Maximum Spool Size Capacity	Dimensions (H x W x D)	Net Weight
Intellex (301493) Single-wire Intellex Pro (301492) ◀ Single-wire Intellex (301541) Dual-wire Intellex Pro (301540) Dual-wire Intellex Elite (301491) Single-wire Intellex Elite (301597) Dual-wire Intellex Elite (301705) Single-wire, CE	50 VDC	600 A at 113 VDC, 60% duty cycle	1.3-19.8 m/min. (50-780 ipm)	0.6-2.0 mm (.023-5/64 in.)	457 mm (18 in.), 27 kg (60 lb.)	Single: 413 x 314 x 708 mm (16.25 x 12.38 x 27.88 in.) Dual: 356 x 457 x 876 mm (14 x 18 x 34.5 in.)	Single: 20.3 kg (44.8 lb.) Dual: 34.9 kg (77 lb.)





# Continuum™ Systems

See literature DC/36.0

Next generation of advanced industrial welding solutions improves productivity through weld quality, ease of use and system flexibility.



Continuum 350 shown with Continuum single-wire feeder. Filler metal sold separately.

## More power – better reliability

Up to 26 percent more welding output (than competitive models) for demanding industrial applications.

## Power source design

Smart and powerful digital design has the fast response needed to deliver the most stable welding performance for better welding results.

Flexible to meet current and future needs with integrated expansion capabilities.

**Welding Intelligence™** Increase productivity, improve quality and manage costs with Insight Core™ (standard) and Insight Centerpoint™ (optional) welding information management systems.

## Feeder design

Tru-Feed™ technology provides precise feeding operation for stable arc performance.

- **Low-inertia motor** provides faster response for the best arc starts with the least amount of spatter
- **Balanced-pressure drive-roll design and tensioners** feed wire in its truest and straightest form for consistent feedability, resulting in better welding performance

**User interface** makes the system easy to set up and adjust with minimal training.

## Continuum Processes

Best For	Standard Spray	High-Deposition MIG	Accu-Pulse	Versa-Pulse	Short Circuit	RMD
Deposition	A	A	A	B	D	D
Gap Filing	D	D	B	B	A	A
Low Heat Input	D	C	B	A	A	A
Out-of-Position Welds			A	B	B	B
Low Spatter	A	A	A	B	C	B
Thick Metals	A	A	A	C	D	D
Thin Metals			B	A	A	A
Increased Travel Speed	A	A	A	A	B	C

HOT  COLD

Ratings A, B, C, and D are relative values. An "A" rating indicates a best fit between your performance needs and process. A "blank" rating indicates that the process is not recommended for that application.

Accu-Pulse is the most popular process for majority of industrial welding applications.

Versa-Pulse is a fast, low-heat, low-spatter process designed for thin-material applications.

RMD is a low-heat modified short-circuit process designed to fill gaps with thin-material applications.

High-deposition MIG provides increased deposition rates over standard spray on thicker materials.

Heavy industrial DC 3 Phase

## Processes

- Accu-Pulse® MIG (GMAW-P)
- Versa-Pulse™ • RMD® • MIG (GMAW)
- High-deposition MIG (GMAW)
- Flux-cored (FCAW)
- Air carbon arc gouging (CAC-A)

## Most popular accessories

- Bernard™ MIG Guns
- Insight Centerpoint™ Software
- Continuum Running Gear/Cylinder Rack 301264
- Continuum Integrated Cooler 301214, **CE**  
Mounts to bottom of Continuum power source. Does not require external power.
- Continuum Control/Motor Cables  
263368003 0.9 m (3 ft.)  
263368015 4.6 m (15 ft.)  
263368020 6.1 m (20 ft.)  
263368025 7.6 m (25 ft.)  
263368050 15 m (50 ft.)  
263368080 24.4 m (80 ft.)  
263368100 30.5 m (100 ft.)
- Industrial MIG 4/0 Kit 300390
- Continuum Feeders  
301195 Single  
301195010 Single, **CE**  
301199 Dual  
301199010 Dual, **CE**
- Continuum Swingarc™ Boom Single  
301219 2.4 m (8 ft.)  
301220 3.7 m (12 ft.)  
301221 3.9 m (16 ft.)  
ROI Single  
301227, **CE**  
Boom Dual 3.7 m (12 ft.) 301223  
ROI Dual 301434, **CE**
- Pipe Post  
149838 1.2 m (4 ft.)  
149839 1.8 m (6 ft.)

\*While idling.

Note: As the technological advances offered by Continuum extend beyond the capability of Access® systems, the two systems are not compatible. Continuum systems are designed to allow future upgradability, to expand with your operation's needs.

Model	Stock Number	Amperage/ Voltage Range	Rated Output	Amps Input at Rated Output, 50/60 Hz, 3-Phase								Max. Open-Circuit Voltage	Net Weight (power source only)
				230V	380V	400V	460V	575V	KVA	KW			
Continuum 350	(907636) 230-575 V Machine only (907636001) 230-575 V w/running gear (907645) 400 V, <b>CE</b>	20-400 A, 10-44 V	300 A at 34 VDC, 100% duty cycle	36.7	21.8	20.8	18.8	14.6	14.4	13.8	75 VDC	57.6 kg (127 lb.)	
				0-1*	0-1*	0-1*	0-1*	0-1*	0.8*	0.17*			
Continuum 500	(907640) 230-575 V Machine only (907640001) 230-575 V w/running gear (907648) 400 V, <b>CE</b>	20-600 A, 10-44 V	500 A at 40 VDC, 100% duty cycle	34.9	–	33.2	28.9	23.3	23.1	21.9	67.1 kg (148 lb.)		
				0-1*	–	0-1*	0-1*	0-1*	0.8*	0.17*			

Model	Stock Number	Input Power	Input Welding Circuit Rating	Wire Feed Speed	Wire Diameter Capacity	Max Spool Size Capacity	Dimensions	Net Weight
Continuum Feeder only	(301195) Single-wire model (301195010) Single-wire model, <b>CE</b> (301199) Dual-wire model (301199 010) Dual-wire model, <b>CE</b>	50 VDC	500 A at 100% duty cycle	Standard: 1.3-25.4 m/min. (50-1000 IPM)	0.9-2.0 mm (.035-.64 in.)	457 mm (18 in.), 27 kg (60 lb.)	H: 351 mm (13.812 in.) Single W: 414 mm (16.312 in.) Dual W: 432 mm (17 in.) D: 754 mm (29.687 in.)	<b>Single</b> 19.5 kg (43 lb.) <b>Dual</b> 27.9 kg (61.5 lb.)



## Auto-Continuum™ Systems

See literature AU/10.0

Next generation automation welding solution delivers advanced arc performance to improve throughput and weld quality.



Auto-Continuum 500 shown with robot arm (not included) and Auto-Continuum wire drive motor assembly.

Closeup of Auto-Continuum wire drive motor assembly (left-hand drive).

Note: As the technological advances offered by Auto-Continuum extend beyond the capability of Access® systems, the two systems are not compatible. Continuum systems are designed to allow future upgradability, to expand with your operation's needs.

**More power — better reliability.** Up to 26 percent more welding output (than competitive models) for demanding industrial applications.

**AUTO-LINE TECHNOLOGY** Allows for any input voltage hookup (230–575 V, three-phase) with no manual linking, providing convenience in any job setting. Ideal solution for dirty or unreliable power.

**Improve work environment and reduce spatter.** Versa-Pulse and Accu-Pulse processes reduce fume generation, and by precisely controlling the welding arc they also reduce spatter size and quantity. Fume generation can be reduced up to 50 percent over traditional CV MIG.

- **Versa-Pulse** is a fast, low-heat, low-spatter process for high-speed automation on thin materials and is great for gap filling
- **Accu-Pulse** is better for out-of-position welds, provides higher deposition rates and is designed for thicker materials than Versa-Pulse

**Easy communication** from robot to power source.

**Designed for easy integration** with fixed and flexible automation.

**Fleet standardization.** Auto-Continuum can be used for both automation and hand-held applications.

**Welding Intelligence.™** Increase productivity, improve quality and manage costs.

- **Insight Core™** (standard) is a simplified, Internet-based welding information solution that reports cell productivity and weld parameter verification
- **Insight Centerpoint™** (optional) is an advanced, real-time feedback solution to ensure consistent weld quality and actively detects a bad weld when it happens, reducing rework costs and improving quality

Heavy Industrial ● CV DC 3 Phase

### Processes

- Accu-Pulse® MIG (GMAW-P)
- Versa-Pulse™ ▪ RMD® ▪ MIG (GMAW)
- High-deposition MIG (GMAW)
- Flux-cored (FCAW)

### Most popular accessories

- Insight Centerpoint™ Software
- Auto-Continuum Robotic MIG Kit 301455  
Consists of 7.6 m (25 ft.) motor control cable, 3.7 m (12 ft.) motor control extension, two 9 m (30 ft.) weld cables, 3.7 m (12 ft.) weld cable extension, 9 m (30 ft.) gas hose, flowmeter regulator, 5 m (16.4 ft.) Ethernet cable, 0.9/1.2 mm (.035/.045-in.) V-groove drive roll kit with guides, and conduit assembly with quick disconnects.
- Wire Drive Motor Mounting Brackets  
301276 ABB® 1600  
301277 ABB® 2600  
300483 FANUC® 100 and 120 IC  
300013 FANUC®/KUKA®/Motoman®  
301282 KUKA® KR5 HW  
301275 KUKA® KR16 HW  
300375 Motoman® EA1400  
300376 Motoman® EA1900
- Motor Control Cables  
263368025 7.6 m (25 ft.)  
263368050 15 m (50 ft.)  
263368080 24.4 m (80 ft.)  
263368100 30.5 m (100 ft.)
- EtherNet/IP™ Communication Cables  
300734 3 m (9.8 ft.)  
300735 5 m (16.4 ft.)  
300736 10 m (32.8 ft.)
- DeviceNet Communication Cables  
300020 2.7 m (9 ft.)  
300021 6.1 m (20 ft.)
- Analog Interface 301547

\*While idling.

Model	Stock Number	Amp/Volt Ranges	Rated Output	IP Rating	Amps Input at Rated Output, 50/60 Hz, 3-Phase						Max. Open-Circuit Voltage	Dimensions (Includes lift eye)	Net Weight	
					230 V	380 V	400 V	460 V	575 V	KVA				KW
Auto-Continuum 350	(907656) EtherNet/IP™ (907658) EtherNet/IP™ with auxiliary power (907660) EtherNet/IP™, CE	20–400 A, 10–44 V	350 A at 31.5 VDC, 100% duty cycle	IP23	36.7	21.8	20.8	18.8	14.6	14.4	13.8	75 VDC	H: 691 mm (27.187 in.) W: 444 mm (17.5 in.) D: 717 mm (28.22 in.)	59.4 kg (130 lb.)
Auto-Continuum 500	(907657) EtherNet/IP™ (907659) EtherNet/IP™ with auxiliary power (907661) EtherNet/IP™, CE	20–600 A, 10–44 V	500 A at 39 VDC, 100% duty cycle	IP23	58.7	34.9	33.2	28.9	23.3	23.1	21.9			75 VDC
Auto-Continuum Wire Drive Motor Assembly (301207) Left-hand drive, CE (301208) Right-hand drive, CE		Input Power	Input Welding Circuit Rating	IP Rating	Wire Feed Speed		Wire Diameter Capacity		Dimensions		Net Weight			
		50 VDC	500 A at 100% duty cycle	IP23	Standard: 1.3–25.4 m/min. (50–1,000 ipm)		0.9–2.0 mm (.035–5/64 in.)		H: 222 mm (8.75 in.) W: 254 mm (10 in.) D: 254 mm (10 in.)		7.5 kg (16.5 lb.)			





For more detailed information, visit

MillerWelds.com/wirefeeders

# WIRE FEEDERS



Also see MIG, MIG Guns and Multiprocess sections for wire feeding options.



## Product Guide

	Class	MIG	Pulsed MIG <sup>1</sup>	RMD <sup>2</sup>	Flux-cored <sup>2</sup>	Gouge	Power Source Required	Wire Types			Wire Diameter Capacity	Special Features	Typical Applications	
								Solid	Flux-cored Gas-shld	Self-shld Alum.				
ArcReach® 16	●	●			●	● <sup>3</sup>	CC/CV	●	●	●		60 lb. spool capacity, powered by arc voltage, remote voltage and process control without a control cord, optimized with XMT® 650 ArcReach power sources, large diameter 3/32 in. wire, isolated gouge stud, available with shop cart or IP23-rated field roller	Structural steel, fabrication, erection	Portable
ArcReach® SuitCase® (8 and 12)	●	●	●		●		CC/CV	●	●	●CV <sup>2</sup>	●	8 in. (SuitCase 8) or 12 in. (SuitCase 12) diameter spool capacity, powered by arc voltage, remote voltage control without a control cord with ArcReach power sources. ArcReach Suitcase 12 Heavy Duty model available for use with large diameter 3/32 in. cored wire	Construction, site fabrication, field maintenance	
ArcReach® Smart Feeder	●	●	●	●	●		ArcReach equipped	●	●			12 in. diameter spool capacity, remote voltage control without a control cord, requires an XMT 350 FieldPro connected to three-phase power or a compatible ArcReach-equipped engine drive	Process piping, refinery, petrochemical, power plants, HVAC, water pipe	
SuitCase® 12RC	●	●	●		●		CV	●	●	●	●	12 in. diameter spool capacity, standard remote voltage control, powered by 14-pin control cord	Field maintenance, site fabrication	
20 Series (Basic and Digital)	●	●	●		●		CV	●	●	●	●	Four quick-change drive rolls, digital meter, remote voltage control (meter and remote voltage control are a field kit option on basic model)	Manufacturing, fabrication	Bench
74 MPa Plus (Single- and Dual-Wire)	●	●	●		●		CV	●	●	●	●	Sequence control, locks and limits, four weld program memories, synergic pulsed MIG with MPa power sources, XR-Aluma-Pro™ Plus or XR™-Pistol Plus guns for feeding soft wires are designed to work with MPa Plus feeders	Manufacturing requiring multiple wire types	
74 MPa Plus Remote Configurations (Single- and Dual-Wire)	●	●	●		●		CV	●	●	●	●	Control box, cables and wire drive motor assemblies for generic booms or fixed automation	Heavy and light manufacturing, fabrication	

### Product Key

Class: ● Light industrial ● Industrial ● Heavy industrial Capability: ● Designed for this process ● Capable of this process

<sup>1</sup> Smart Feeder requires an XMT® 350 FieldPro™ connected to three-phase power or a compatible ArcReach-equipped engine drive. All other feeders require an MPa inverter power source.

<sup>2</sup> Certain self-shielded wires require CV output. Miller recommends a CV power source whenever possible.

<sup>3</sup> ArcReach 16 requires an XMT® 650 power source to gouge.





## SuitCase® Series Portable Feeders

Portable SuitCase feeders that set the standard for performance and provide extreme reliability to stand up to the demands of construction and fabrication.



### SuitCase Series Features

Feature	ArcReach			12RC
	8	12	Smart	
Remote voltage control (control cord required)				●
Remote voltage control (without a cord)	●	●	●	
Digital meters	●	●	●	●
Impact-resistant case	●	●	●	●
Gas purge	●	●	●	●
Wire jog	●	●	●	●
● Standard				

Note: ArcReach SuitCase feeders are compatible with standard power sources and engine-driven welders, but function as standard equipment without remote control capabilities. Full functionality of ArcReach is only available with ArcReach power sources.

### Setting the standard for performance

**Heavy-duty drive motor with tachometer control** provides wire feed speed that is accurate and consistent from the start of the weld to the finish and from one weld to the next. Consistent wire feed speed is very important with large-diameter cored wire, because small changes in wire feed speed make large changes in deposition rates.

**Wide voltage range** for small and large wires with no contactor chatter or arc outages.

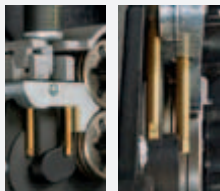

**Ultra-low drag inlet guide pins** make loading the wire easy and does not deform the wire on the way into the drive rolls improving wire feeding performance.



**Scaled wire pressure knob** provides easy adjustment and consistent pressure on the drive rolls and wire.

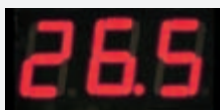

**Digital meters with SunVision™ technology** can display voltage, wire feed speed, and also amperage if desired. Meters can be seen clearly even in direct sunlight.

### Unique and durable case

**Impact-resistant, flame-retardant case** provides strength and durability, and protects components and welding wire from moisture, dust and other contaminants.

**Built-in slide rails** allow you to drag the feeder into position for welding.

**Innovative feeder door design** allows you can change wire while feeder is standing upright or laying down.

### Extreme reliability

**Potted and trayed main printed circuit board** for the harshest environments adds exceptional reliability. Board has full-trigger isolation so a shorted gun trigger will not affect feeder operation.



**Gun locking tab** works with guns and Euro-adapter having corresponding locking grooves to prevent gun from being pulled out if the feeder is dragged by the gun.



**Gas inlet recessed into back of case** is protected from incidental contact by the weld cable, ensuring consistent and contaminant-free shielding gas delivery to the gun. **Double-filtered gas valve** helps keep dirt from clogging and affecting gas flow.



# ArcReach® SuitCase® 8 and 12 and ArcReach Smart Feeder

See literature M/6.55

**ArcReach** Remote control of the power source without a cord. With a ArcReach SuitCase feeder and ArcReach power source you can change output voltage at the feeder, and save a trip to the power supply. No extra control cable to purchase, maintain, string or unstring – saving time and money.

**Easy process changeover.** Simply connect the ArcReach feeder to your leads and you are ready to go. All controls automatically shift to the ArcReach feeder.

**Voltage-sensing feeders designed to run off of arc voltage.** The ArcReach SuitCase 8 and 12 operate on the arc voltage of almost any power source. The ArcReach Smart Feeder requires an XMT® 350 FieldPro™ connected to three-phase power or an ArcReach-equipped engine drive.

## Additional features of ArcReach Smart Feeder

**Delivers excellent synergic RMD® and pulsed MIG welding** up to 61 meters (200 ft.) away from the power source with no control cords – twice the distance previously possible. RMD and pulsed MIG welding permits procedures with one wire and one gas to eliminate process switch-over time. RMD and pulsed MIG processes also help reduce weld failures and eliminate backing gas on some stainless and chrome-moly applications.

## SuitCase® 12RC

See literature M/6.5

**Standard remote voltage control with a control cord.** For applications where the feeder is within 30.5 meters (100 ft.) of the power source and control cords are acceptable. Requires power source with 14-pin connector.

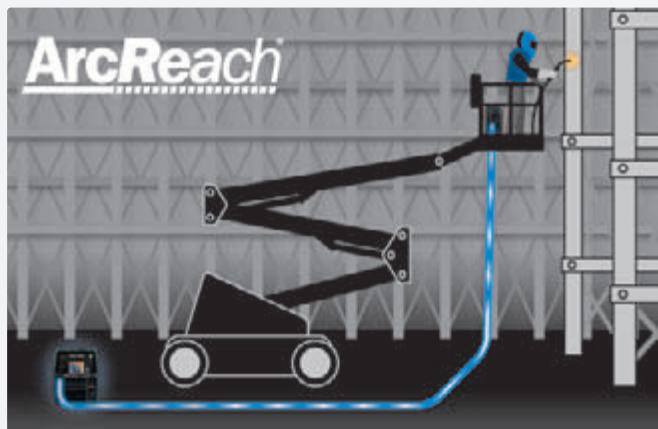

Heavy industrial CC CV DC

Use with CC/CV (CV only with 12RC), DC power sources. See spec chart below for Smart Feeder requirements.

### Processes

- MIG (GMAW) ▪ Flux-cored (FCAW)
- RMD and pulsed MIG (GMAW-P) with ArcReach Smart Feeder

### Suggested power sources

Note: ArcReach SuitCase feeders are compatible with standard power sources and engine-driven welders, but function as standard equipment without remote control capabilities. Full functionality of ArcReach is only available with ArcReach power sources.

#### For ArcReach SuitCase 8 and 12

- Maxstar® 280 Multiprocess
- Dynasty® 300 Multiprocess
- XMT® Series
- Bobcat™ Series
- Trailblazer® Series
- Big Blue® Series

#### For ArcReach Smart Feeder

- XMT® 350 FieldPro (requires three-phase power)
- Big Blue® Series (ArcReach models only)

#### For SuitCase 12RC (requires power source with 14-pin connector)

- XMT® Series
- Trailblazer® Series
- Big Blue® Series

### Suggested guns

- Bernard® Guns

### Most popular accessories

- Extension Cables (for SuitCase 12RC only, 1 required)
- Flowmeter Kit 300343
- Shielding Gas Filter 195189
- Dinse 70 Series 134460 Male 136600 Female

	Model/Stock Number	Input Power	IP Rating	Input Welding Circuit Rating	Wire Feed Speed	Wire Type and Diameter Capacity	Maximum Spool Size Capacity	Dimensions	Net Weight
ArcReach	ArcReach Suitcase 8 (301457) Tweco®, CE	Operates on open-circuit voltage and arc voltage: 14-48 VDC/ 110 max. OCV	IP23	330 A at 60% duty cycle	1.3-19.8 mpm (50-780 ipm) Actual range in CC mode is dependent on arc voltage applied	Solid wire 0.6-1.4 mm (.023-.052 in.) Flux-cored 0.8-2.0 mm (.030-5/64 in.)	203 mm (8 in.), 6.4 kg (14 lb.)	H: 324 mm (12.75 in.) W: 184 mm (7.25 in.) D: 457 mm (18 in.)	13 kg (28 lb.)
	425 A at 60% duty cycle								
	ArcReach Suitcase 12 (301456) Tweco®, CE					Solid wire 0.6-1.4 mm (.023-.052 in.) Flux-cored 0.8-2.0 mm (.030-5/64 in.)	305 mm (12 in.), 20 kg (45 lb.)	H: 394 mm (15.5 in.) W: 229 mm (9 in.) D: 533 mm (21 in.)	15.9 kg (35 lb.)
	ArcReach Smart Feeder (301177) Dinse, CE (300935) Tweco® (300935002) Tweco® w/flowmeter	XMT 350 FieldPro or PipeWorx 350 FieldPro connected to three-phase power or an ArcReach-equipped engine drive	IP23	275 A at 60% duty cycle	1.3-19.8 mpm (50-780 ipm) dependent on arc voltage	0.9-1.1 mm (.035-.045 in.)	305 mm (12 in.), 15 kg (33 lb.)	H: 457 mm (18 in.) W: 330 mm (13 in.) D: 546 mm (21.5 in.)	23 kg (50 lb.)
	SuitCase 12RC (301121) Tweco®, CE	24 VAC, 10 A, 50/60 Hz	IP23	425 A at 60% duty cycle	1.3-17.8 mpm (50-700 ipm)	Solid wire 0.6-1.4 mm (.023-.052 in.) Flux-cored 0.8-2.0 mm (.030-5/64 in.)	305 mm (12 in.), 20 kg (45 lb.)	H: 394 mm (15.5 in.) W: 229 mm (9 in.) D: 533 mm (21 in.)	14.1 kg (31 lb.)



## ArcReach® 16 Portable Feeder

See literature DC/18.98

**Portable feeder that takes productivity, cost savings, and power to the next level for structural steel fabrication and erection.**

### ArcReach 16 Features

Feature	
Available with Bernard Gun: BTB Gun 400 A	●
IronPro 450-15 gun	●
Remote voltage control (without a cord)	●
Gouge	●
Digital meters	●
Gas purge	●
Wire jog	●
Feeds 2.4 mm (3/32 in.) wire	●
Available with shop cart or field roller	●



ArcReach 16 with shop cart

ArcReach 16 with field roller

**ArcReach® Remote control of the power source without a cord.** With an ArcReach 16 feeder and XMT 650 ArcReach power source you can change output voltage at the feeder, and save a trip to the power supply. No extra control cord to purchase, maintain, string or unstring – saving time and money.

**Easy process changeover.** Simply connect the ArcReach 16 wire feeder to your weld lead and you are ready to go. Switch between welding and gouging with a push of a button with no need to swap leads or disconnect the wire feeder with isolated outputs.

**Integrated gouging stud** on wire feeder. Isolated gouging stud allows easy connection for gouging at point of use, eliminating the need to disconnect the wire feeder and to swap leads.

**Voltage-sensing feeder designed to run off of arc voltage.** The ArcReach 16 operates on the arc voltage of almost any power source, but is best paired with an XMT 650 model.

**Weld with up to 27.2 kg (60 lb.) spools and large diameter (2.4 mm [3/32 in.]) wire** to minimize downtime and maximize productivity.

**Easy mobility in the shop and on-site (optional shop cart and field roller).** The ArcReach 16 wire feeder preassembled options include a shop cart and a field roller.

- **Shop cart** provides easy shop mobility with low clearance. Handle doubles as a cable holder.
- **Field roller** provides easy field mobility over pan decking and other surfaces. Designed for the environment with spool cover and IP23 rating. Includes spool cover, hanging bail and cable holder.

**Heavy industrial** **CC CV DC**

Use with CC/CV, DC power sources.

### Processes

- MIG (GMAW) = Flux-cored (FCAW)
- Air carbon arc cutting and gouging (CAC-A) (rated 9.5 mm [3/8 in.] carbons) with XMT 650 power source

### Suggested power sources

*Note: ArcReach 16 feeder is compatible with standard power sources and engine-driven welders, but functions as standard equipment without remote control capabilities. Full functionality of ArcReach is only available with XMT 650 ArcReach power source.*

- XMT® 650 Series

### Suggested guns

- Bernard® BTB Gun 400 A



- **Bernard® IronPro™ 450-15 293039**  
Self-shielded gun designed for ironworkers and structural steel erectors to excel in the outdoors with large diameter self-shielded flux cored wire up to 2.4 mm (3/32 in.) – sealed trigger remains slag and spatter free for extended life and ergonomic design provides excellent access and maneuverability for hard-to-reach weld joints

### Most popular accessories

- Inline Filter 211989
- Wire Reel Assembly 108008

Stock Number	Input Power	Input Welding Circuit Rating	Wire Feed Speed	Wire Type and Diameter Capacity	Max. Spool Size Capacity	Dimensions (H x W x D)	Net Weight
<b>301619</b> Base feeder only	Operates on open-circuit voltage and arc voltage: 12-110 VDC	450 A at 100% duty cycle	1.3-19.8 m/min. (50-780 ipm) dependent on arc voltage	<b>Solid wire</b> 0.9-1.9 mm (.035-5/64 in.) <b>Flux-cored</b> 1.1-2.4 mm (.045-3/32 in.)	457 mm (18 in.) 27.2 kg (60 lb.)	<b>Base feeder</b> 388 x 424 x 833 mm (15.3 x 16.7 x 32.8 in.)	<b>Base feeder</b> 45.8 kg (101 lb.)
<b>301664</b> With shop cart		500 A at 60% duty cycle				<b>Shop cart</b> 508 x 632 x 922 mm (20 x 24.9 x 36.3 in.)	<b>Shop cart</b> 54.4 kg (120 lb.)
<b>301663</b> With field roller		<b>CAC-A</b> 600 A at 40% duty cycle				<b>Field roller</b> 716 x 505 x 1,084 mm (28.2 x 19.9 x 42.7 in.)	<b>Field roller</b> 55.7 kg (123 lb.)





## 20 Series and 74 MPa Plus

### Heavy-Industrial Bench Feeders

Designed for manufacturing, our popular bench feeders are available in two series with multiple models to fit your needs.



#### 20 Series and 74 MPa Plus Features

Feature	20 Series		74 MPa Plus
	Basic	Digital	
Available w/Bernard® gun: BTB Gun 400 A	●	●	●
Trigger hold	●	●	●
Digital meter(s)	●	●	●
Remote voltage control	●	●	●
Adjustable run-in control	●	●	●
Automatic run-in control	●	●	●
Dual-wire models	●	●	●
Rotatable drive assembly	●	●	●
Accu-Mate™	●	●	●
Preflow/postflow	●	●	●
Spot control	●	●	●
Dual schedule control	●	●	●
Trigger program select	●	●	●
Trigger dual schedule	●	●	●
Sequence control	●	●	●
Locks and limits	●	●	●
Weld programs	●	●	4
Trigger schedule select	●	●	●
Push-pull capability	●	●	●
Synergic pulsed MIG	●	●	●
Profile Pulse™	●	●	●

● Standard ● Field option

Feeders **include** a 3 m (10 ft.) interconnecting cord.

**Trigger hold** allows the operator to make long welds without having to hold the trigger continuously. Reduces operator fatigue.

**Miller® standard quick-change drive rolls save time.**

**Quick-release drive-roll pressure arm** allows drive roll change without losing spring preload setting.

**Easy loading and threading of welding wire** without having to release the drive roll pressure arm.

**Four gear-driven drive rolls** provide more consistent feeding on larger wire diameters.

## 20 Series (Basic and Digital) See literature M/11.0

Simple and cost-effective feeders for heavy-industrial manufacturing and fabricating.

**Ideal for most high-duty-cycle applications** requiring day-in/day-out trouble-free operation.

**On-board burnback and motor ramp control** for excellent starting and stopping performance.

**Digital meter (standard on digital model, field option on basic model)** ensures accuracy when presetting and reading actual voltage, amperage and wire feed speed.

**Remote voltage control (standard on digital model, field option on basic model)** at feeder for easier adjustments in the weld cell.

**Adjustable run-in control (standard on digital model, field option on basic model)** for better arc-starting performance on a variety of wires.



## 74 MPa Plus See literature M/3.0

Feeders for heavy-duty industrial applications with features for weld control and programs, plus push-pull aluminum capabilities. Optimized with AlumaPower™ MPa or XMT® MPa power sources.

**Available in dual-wire models** which allow two different wire types to be available on one feeder, avoiding downtime from changing spools and drive rolls.

**Toolless rotatable drive assembly** allows operator to rotate the drive housing, allowing a straight path for wire flow.

**Accu-Mate™** properly seats the MIG gun power pin for best feeding performance.

**High-torque permanent-magnet motor, sealed ball bearing gear drive and solid-state speed and brake control** are maintenance free for long life.

**Digital meters** ensure accuracy when presetting and reading actual voltage, amperage and wire feed speed.

**Remote voltage control** allows you to set both voltage and wire feed speed at the feeder, saving time and increasing weld quality.

**Adjustable run-in control** for improved arc starts.

**Dual schedule control** allows the operator to switch between two preconfigured welding parameters without readjusting the machine, saving time and enhancing quality.

**Trigger schedule select** saves time when switching between two weld settings by simply tapping gun trigger.

**Trigger program select** provides the ability to access any of the four active programs.

**Sequence control** gives the operator the ability to adjust all of the welding parameters: preflow, run-in, weld time, crater, burnback and postflow.

**Locks and limits** for restricting or limiting operator adjustments, such as voltage and wire feed speed parameters.

**Four weld program memories** allow operators to recall up to four previously used processes and their weld settings.

**Push-pull capability** provides consistent, versatile and dependable aluminum wire feeding over greater distances.

### Recommended aluminum solution.

XR Plus guns (gooseneck and pistol grip) are designed to work with MPa Plus feeders to coordinate wire feed speed of the gun and the feeder. This provides optimized aluminum feeding and welding performance. See chart below for gun models and stock numbers.

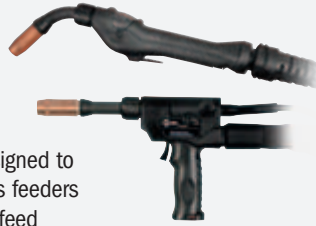

### Additional features when used with AlumaPower MPa or XMT MPa power sources

**Synergic pulsed MIG.** As wire speed increases/decreases, pulse parameters also increase/decrease to match the right amount of power needed, reducing the need to make additional adjustments.

**Profile Pulse™** provides TIG appearance with MIG simplicity and productivity.

Achieve “stacked dimes” without gun manipulation. Profile Pulse frequency can be changed to increase or decrease the spacing between the ripple pattern to achieve the desired weld appearance.



## Heavy Industrial **CV DC**

Use with CV, DC power sources.

### Processes

- MIG (GMAW) = Flux-cored (FCAW)
- Pulsed MIG (GMAW-P) with MPa Plus feeder and MPa power source

### Suggested power sources

- AlumaPower™ MPa
- XMT® Series

### Suggested guns

- Bernard® Guns
- XR-Aluma-Pro™ Plus and XR™-Pistol Plus (see chart below)

### Most popular accessories

- Feeder Cart 142382
- Extension Cables
- Spool Adapter 047141
- Turntable Assembly 146236
- Wire Straightener
- Field Kits for 20 Series Basic 301513 Digital meter and remote voltage control
- 301515 Run-in control
- Hanging Bail 058435
- Spool Covers 057607 For 20 Series and 74 MPa Plus single-wire models and left side of dual-wire models
- 090389 For right side of 74 MPa Plus dual-wire models
- Wire Reel Assembly 108008
- Remote configurations are available – see literature M/3.0

\*Requires wire kit (230708) to run 1.6 mm (1/16 in.) wire.

Model	Stock Number	Input Power	Wire Feed Speed	Wire Type and Diameter Capacity	Maximum Spool Size Capacity	Dimensions	Net Weight	
20 Series	Basic 301499, CE Digital 301499001, CE	24 VAC, 3.5 A, 50/60 Hz	1.9–19 m/min. (75–750 ipm)	0.6–2.0 mm (.023–5/64 in.)	27 kg (60 lb.) coil with optional wire reel assembly (108008)	H: 406 mm (16 in.) W: 314 mm (12.375 in.) D: 708 mm (27.875 in.)	21 kg (46 lb.)	
74 MPa Plus	300577 S-74 MPa Plus single-wire feeder, CE	24 VAC, 10 A, 50/60 Hz	1.3–19.8 m/min. (50–780 ipm)	Solid wire 0.6–2.0 mm (.023–5/64 in.) Aluminum* 0.9–1.6 mm (.035–1/16 in.)	27 kg (60 lb.) coil with optional wire reel assembly (108008)	H: 356 mm (14 in.) W: 318 mm (12.5 in.) D: 711 mm (28 in.)	21.2 kg (48 lb.)	
	300578 D-74 MPa Plus dual-wire feeder, CE					H: 356 mm (14 in.) W: 533 mm (21 in.) D: 889 mm (35 in.)	39.5 kg (87 lb.)	
Optional Push-Pull Gun (For MPa Plus feeders only)	Cable Length			Welding Current Rating	Wire Feed Speed	Wire Type and Diameter Capacity	Dimensions	Net Weight
	4.6 m (15 ft.)	7.6 m (25 ft.)	10.6 m (35 ft.)					
XR-Aluma-Pro Plus (Air-cooled)	301575	301574	–	300 A at 100% duty cycle	1.8–23 m/min. (70–900 ipm)	Aluminum* 0.8–1.6 mm (.030–1/16 in.)	H: 127 mm (5 in.) W: 64 mm (2.5 in.) L: 432 mm (17 in.)	1.1 kg (2.5 lb.)
XR-Aluma-Pro Plus (Water-cooled)	301576, CE	301577, CE	–	400 A at 100% duty cycle			1.3 kg (2.9 lb.)	
XR-Pistol Plus (Air-cooled)	300753	300754	–	200 A at 100% duty cycle	1.8–23 m/min. (70–900 ipm)	Aluminum* 0.8–1.6 mm (.030–1/16 in.)	H: 187 mm (7.375 in.) W: 48 mm (1.875 in.) L: 270 mm (10.625 in.)	1 kg (2.2 lb.)
XR-Pistol Plus (Water-cooled)	–	300757	–	400 A at 100% duty cycle			1.1 kg (2.4 lb.)	



## 74 MPa Plus Remote Configurations See literature M/3.0

Remote wire feeder control box and wire drive assembly for non-Miller boom applications.

**Single-wire control box**  
**300738** S-74 MPa Plus, CE

**MPa Plus motor control cable (14 conductor)**  
**254864010** 3 m (10 ft.)  
**254864025** 7.6 m (25 ft.)  
**254864050** 15.2 m (50 ft.)

**Wire drive motor assembly**  
**300740** MPa Plus left-hand drive, CE  
*For use with push-only guns, OR XR-Aluma-Pro™ Plus and XR™-Pistol Plus push-pull guns.*

*Gun NOT included. Must be ordered separately.*

**Dual-wire control box**  
**300739** D-74 MPa Plus, CE

*Note: Right-side drive in dual-remote configurations is push-only.*

**Right-side motor control cable (11 conductor)**  
**254935010** 3 m (10 ft.)  
**254935025** 7.6 m (25 ft.)

**Push-only wire drive motor assembly**  
**300741** Right-hand drive, CE

**MPa Plus motor control cable (14 conductor)**  
**254864010** 3 m (10 ft.)  
**254864025** 7.6 m (25 ft.)  
**254864050** 15.2 m (50 ft.)

**Wire drive motor assembly**  
**300740** MPa Plus left-hand drive, CE  
*For use with push-only guns, OR XR-Aluma-Pro™ Plus and XR™-Pistol Plus push-pull guns.*

*Gun NOT included. Must be ordered separately.*

Heavy industrial **CV DC**

Use with CV, DC power sources.

### Processes

- MIG (GMAW) ▪ Flux-cored (FCAW)
- Pulsed MIG (GMAW-P) with MPa Plus configurations and MPa power source

### Suggested power sources/guns

- Same as 74 MPa Plus bench feeder

### Most popular accessories



- **Feeder Base** 195369  
 For use with spooled wire

## For All Your Industrial MIG Gun and Consumable Needs

Our Bernard® and Tregaskiss® catalog and website provide one source for all your semi-automatic, robotic, and fixed automatic MIG welding gun and consumable needs.

Visit us online today at **Tregaskiss.com** to access product information, use our online product configurators and learn how to get more out of your welding applications. While you're there you can **request a hard copy of the latest Bernard and Tregaskiss MIG Welding Guns and Consumables catalog** or **sign up for Amperage**, our electronic newsletter.



**Tregaskiss.com**







# MIG Guns

For more detailed information, visit



MillerWelds.com/guns-torches

## Product Guide

	Class	MIG	Pulsed MIG	Flux-cored*	Solid	Wire Types			Wire Diameter Capacity	Available Cable Lengths	Typical Applications
						Flux-cored		Alum.			
						Gas-shld	Self-shld				
Steel	MIGmatic™ M-100 MIG Gun	●	●	○	●	○	○	○	0.6-1.2 mm (.023-.045 in.)	10 ft.	Light industrial steel fabrication
	MIGmatic™ M-150 MIG Gun	●	●	○	●	○	○	○	0.6-1.2 mm (.023-.045 in.)	15 ft.	Light industrial steel fabrication
	MDX™-100 MIG Guns	●	●	○	●	○	○	○	0.6-1.2 mm (.023-.045 in.)	10 or 15 ft.	Light industrial steel fabrication
	MDX™-250 MIG Guns	●	●	○	●	○	○	○	0.6-1.2 mm (.023-.045 in.)	10 or 15 ft.	Industrial steel fabrication
	Bernard® BTB MIG Guns	●	●	○	●	○	○	○	0.6-3.2 mm (.023-1/8 in.)	10, 15, 20, or 25 ft.	Heavy industrial steel fabrication
	Bernard® Clean Air™ Fume Extraction Guns	●	●	○	●	○	○	○	0.6-3.2 mm (.023-1/8 in.)	8, 10, 12, 15, 20, or 25 ft.	Heavy industrial steel fabrication
	Bernard® IronPro™ Self-Shielded Flux-Cored Gun	●			●			○	1.8-2.4 mm (.072-3/32 in.)	15 ft.	Heavy industrial steel fabrication
Aluminum	Spoolmate™ Spool Guns	●	●		●			●	100/200/3035 models: 0.6-0.9 mm (.023-.035 in.) 150 model: 0.8-0.9 mm (.030-.035 in.)	100 model: 12 ft. 150/200/3035 models: 20 ft.	Light industrial aluminum fabrication
	Spoolmatic® Spool Guns	●	●	○	●		○	●	0.8-1.6 mm (.030-1/16 in.)	15 or 30 ft.	Industrial aluminum fabrication
	XR-Aluma-Pro™ Lite Push-Pull Gun	●	●	○	●			●	0.8-1.2 mm (.030-.047 in.)	25 ft.	Industrial aluminum fabrication
	XR-Aluma-Pro™ Push-Pull Guns	●	●	○	●			●	0.8-1.6 mm (.030-1/16 in.)	15, 25 or 35 ft.	Heavy industrial aluminum fabrication
	XR™-Pistol Push-Pull Guns	●	●	○	●			●	0.8-1.6 mm (.030-1/16 in.)	XR-Pistol: 15 or 30 ft. XR-Pistol-Pro: 15, 25 or 35 ft.	Heavy industrial aluminum fabrication

### Product Key

Class: ● Light industrial ● Industrial ● Heavy industrial Capability: ● Designed for this process ○ Capable of this process  
\*Certain self-shielded wires require CV output. Miller recommends a CV power source whenever possible.

## MIGmatic™ M-Series MIG Guns

See literature AY/15.0

Upgrade your M-100 and M-150 MIG guns to AccuLock™ MDX™ consumables with a conversion diffuser.



### AccuLock™ MDX™ Conversion Kit 1880269

Kit features a conversion diffuser to consolidate MIG nozzles and contact tips to AccuLock MDX. Includes diffuser (1070115), 12.7 mm (1/2 in.) flush nozzle (NS-M1200C), five 0.8 mm (.030 in.) contact tips (T-M030), five 0.9 mm (.035 in.) contact tips (T-M035) and a consumables storage box.

### Light industrial ●

#### Processes

- MIG (GMAW) ■ Flux-cored (FCAW)

#### Suggested power sources

- Millermatic® 211 (M-100/M-150)
- Multimatic® 215 (M-100/M-150)
- Multimatic® 220 (M-100/M-150)

#### Most popular accessories

- MIGmatic M-Series Consumable Kits  
234607 0.6 mm (.023 in.)  
234608 0.8 mm (.030 in.)  
234609 0.9 mm (.035 in.)

- AccuLock™ MDX™ Conversion Kit 1880269

Allows MIGmatic M-100 and M-150 MIG guns to upgrade to AccuLock™ MDX™ nozzles and tips

Model	Stock Number	Cable Length	Rated Output	Rated Duty Cycle	Wire Diameter Capacity	Gun Only Net Weight
M-100	248282	3 m (10 ft.)	100 A	100% with CO <sub>2</sub> gas, 60% with mixed gas	0.6-1.2 mm (.023-.045 in.)	1.5 kg (3.2 lb.)
M-150	249041	4.6 m (15 ft.)	150 A	100% with CO <sub>2</sub> gas, 60% with mixed gas	0.6-1.2 mm (.023-.045 in.)	2.7 kg (6.0 lb.)



## MDX™ Series MIG Guns See literature AY/15.5

An ideal match for Miller® all-in-one MIG machines or other Miller® wire feeders.



**Durable, ergonomic handle** features rubber overmolding for improved grip and rear swivel to reduce welder fatigue.

**AccuLock™ consumables** provide long life and superior wire feeding. See below for more information.

**Pulse welding capable (MDX-250 only)** due to increased copper in the gun cable which ensures reliable performance with CV and pulse waveforms.

Light industrial ● MDX-100  
Industrial ● MDX-250

### Processes

- MIG (GMAW) ▪ Flux-cored (FCAW)
- Pulsed MIG (GMAW-P) with MDX-250

### Suggested power sources

#### For MDX-100

- Millermatic® 142/211
- Multimatic® 215
- Multimatic® 220 AC/DC

#### For MDX-250

- Millermatic® 252
- Millermatic® 255
- Multimatic® 235
- Multimatic® 255

### Most popular consumables

#### AccuLock Consumables

##### Power Pin Caps

- 2200360** 0.6–0.8 mm
- 2200361** 0.8–0.9 mm
- 2200362** 0.9–1.2 mm

##### Liners

- LM1A-10** 0.6 mm, 3.0 m length
- LMD2A-10** 0.8–0.9 mm, 3.0 m length
- LMD3A-10** 0.9–1.2 mm, 3.0 m length
- LM1A-12** 0.6 mm, 3.7 m length
- LMD2A-12** 0.8–0.9 mm, 3.7 m length
- LMD3A-12** 0.9–1.2 mm, 3.7 m length
- LM1A-15** 0.6 mm, 4.6 m length
- LMD2A-15** 0.8–0.9 mm, 4.6 m length
- LMD3A-15** 0.9–1.2 mm, 4.6 m length

##### Diffusers

- D-M100** MDX-100
- D-M250** MDX-250
- D-MA250M** MDX-250 AccuLock S conversion

##### MDX-100 Nozzles (mm)

- NS-M1200B** 12.7 ID, flush, brass
- NS-M1200C** 12.7 ID, flush, copper
- NS-MFLX** Gasless nozzle

##### MDX-250 Nozzles (mm)

- AccuLock MDX**
- N-M1200C** 12.7 ID, flush, copper
- N-M1218C** 12.7 ID, 3.2 rec., copper
- N-M5800C** 15.9 ID, flush, copper
- N-M5818C** 15.9 ID, 3.2 rec., copper
- N-M58XTC** 15.9 ID, 3.2 ext., copper
- AccuLock S**
- N-A5800CM** 15.9 ID, flush, copper
- N-A5818CM** 15.9 ID, 3.2 rec., copper
- N-A5814CM** 15.9 ID, 6.4 rec., copper

##### Contact Tips

- AccuLock MDX**
- T-M023** 0.6 mm (.023 in.)
- T-M030** 0.8 mm (.030 in.)
- T-M035** 0.9 mm (.035 in.)
- T-M045** 1.2 mm (.045 in.)
- T-M047** 1.2 mm (3/64 in.)

##### AccuLock S

- T-A023CHM** 0.6 mm (.023 in.)
- T-A030CHM** 0.8 mm (.030 in.)
- T-A035CHM** 0.9 mm (.035 in.)
- T-A039CHM** 1.0 mm (.039 in.)
- T-A045CHM** 1.2 mm (.045 in.)

## AccuLock™ MDX™ Consumables See literature AY/15.5

**Flawless wire feeding path.** Front-loading liner is locked and concentrically aligned with both the contact tip and power pin.

**Error-proof liner trimming** ensures accurate replacement every time – no measuring required!

**Maximize electrical conductivity and tip life.** Tapered mating surface between the contact tip and gas diffuser locks tips in place for optimal performance.

**AccuLock MDX power pin caps** are available in three wire range sizes. They work together with AccuLock gas diffusers to lock and concentrically align the liner to both the contact tip and power pin to ensure smooth, uninterrupted delivery of the wire to the weld puddle.



**Upgrade to AccuLock S consumables** for increased durability and longer life when guns are used in pulsed welding or more industrial applications.



AccuLock MDX

AccuLock S

### MDX Series MIG Guns Consumable Kits



#### For MDX-100 with AccuLock MDX

- 1880272** 0.6 mm (.023 in.)
- 1880273** 0.8 mm (.030 in.)
- 1880274** 0.9 mm (.035 in.)

#### For MDX-250 with AccuLock MDX

- 1880275** 0.8 mm (.030 in.)
- 1880276** 0.9 mm (.035 in.)
- 1880277** 1.2 mm (.045 in.)

#### For MDX-250 with AccuLock S

- 1880278** 0.9 mm (.035 in.)
- 1880279** 1.2 mm (.045 in.)

Kits include ten contact tips, one nozzle, one diffuser, and a consumable storage box. Both kits for MDX-250 gun also include one neck insulator.



## Spoolmate™ Spool Guns

Reliable and economical spool guns designed for light fabricators.



Spoolmate 100

Spoolmate 100 includes carrying case that holds gun and cable, extra contact tips, nozzle and wire (wire sold separately).

### Spoolmate 100 See literature M/1.45

**Light industrial gun** for 4043 series aluminum wire rated at 135 amps at 30 percent duty cycle.

**3.7 m (12 ft.) direct-connect cable** with heavy-duty strain relief provides extended reach and accessibility to your work.

**Dual V-knurl drive rolls with adjustable tension control** for consistent feeding of different types of wire.

**Clear spool canister** protects the wire and allows easy view of spool.

**Includes carrying case, extra contact tips and nozzle.**



Spoolmate 150

### Spoolmate 150 See literature M/1.46

**Light industrial gun** for 4000 or 5000 series aluminum wire rated at 150 amps at 60 percent duty cycle.

**6 m (20 ft.) direct-connect cable** with heavy-duty strain relief provides extended reach and accessibility to your work.

**Heavy-duty head tube.**

**Dual V-knurl drive rolls with adjustable tension control** for consistent feeding of different types of wire.

**Clear spool canister** protects the wire and allows easy view of spool.

**PORTABLE!**



Spoolmate 200

### Spoolmate 200 See literature M/1.47

**Light industrial gun** for 4000 or 5000 series aluminum wire rated at 160 amps at 60 percent duty cycle.

**6 m (20 ft.) weld/control cables** with strain relief and sheath provide extended reach and accessibility to your work.

**Wire feed speed adjustment on the gun** – not machine – for easy setup.

**Easy access to drive assembly and drive rolls.**

**Two-stage trigger with built-in gas valve** allows for gas preflow/postflow.

**Toolless head tube removal** allows easy replacement. Comes standard with heavy-duty head tube. Three optional head tubes available.



Spoolmate 3035

### Spoolmate 3035 See literature M/1.5

**Light industrial gun** for 4000 or 5000 series aluminum wire rated at 150 amps at 60 percent duty cycle.

**6 m (20 ft.) weld/control cables** with strain relief and sheath provide extended reach and accessibility to your work.

**Light weight and well balanced** for operator comfort.

**Clear spool canister** protects the wire and allows easy view of spool.

**Easy-to-remove head tube assembly.**

Light industrial ● **CV DC**

Use with CV, DC power sources.

#### Processes

- MIG (GMAW) with aluminum and other soft alloy wires
- MIG (GMAW) with solid wires

#### Suggested power sources

##### For Spoolmate 100

- Millermatic® 142/211
- Multimatic® 215
- Multimatic® 220 AC/DC
- Multimatic® 235
- Syncrowave® 210 (requires MIG accessory kit 301254)

##### For Spoolmate 150

- Millermatic® 142/211
- Multimatic® 215
- Multimatic® 220 AC/DC
- Multimatic® 235
- Syncrowave® 210 (requires MIG accessory kit 301254)

##### For Spoolmate 200

- Millermatic® 252
- Millermatic® 255
- Millermatic® 355
- Multimatic® 235
- Multimatic® 255
- Bobcat™ 200 Air Pak™
- Bobcat™ 265
- Trailblazer® Series

##### For Spoolmate 3035

- Direct connect to vintage Millermatic 210/212 tapped-voltage models

#### Most popular accessories

##### For Spoolmate 200

- 45-Degree Head Tube 300591
- 229 mm (9 in.) Extension Head Tube 300592
- 127 mm (5 in.) Head Tube 243385
- Spoolmatic Adapter Cable 195287 (Allows connection to older Millermatic 210 and 212 (non-Auto-Set).)

##### For Spoolmatic 3035

- Heavy-Duty Head Tube 195375

Model/ Stock Number	Welding Current Rating	Wire Feed Speed	Wire Type and Diameter Capacity	Maximum Spool Size Capacity	Dimensions	Net Weight with Cable Assembly
<b>Spoolmate 100</b> 300371	135 A at 30% duty cycle	1.7–15.9 m/min. (5–625 ipm) Wire speed dependent on power source used	<b>Aluminum</b> 0.8–0.9 mm (.030–.035 in.) <b>Solid steel</b> 0.6–0.9 mm (.023–.035 in.) <b>Stainless</b> 0.6–0.9 mm (.023–.035 in.)	102 mm (4 in.)	H: 291 mm (11.5 in.) W: 76 mm (3 in.) L: 330 mm (13 in.)	2.7 kg (6 lb.) 4.1 kg (9 lb.) with case
<b>Spoolmate 150</b> 301272	150 A at 60% duty cycle	2.9–18.1 m/min. (115–715 ipm) Wire speed dependent on power source used	<b>Aluminum</b> 0.8–0.9 mm (.030–.035 in.) <b>Solid steel</b> 0.8–0.9 mm (.030–.035 in.) <b>Stainless</b> 0.8–0.9 mm (.030–.035 in.)	102 mm (4 in.)	H: 291 mm (11.5 in.) W: 76 mm (3 in.) L: 318 mm (12.5 in.)	3.2 kg (7.3 lb.)
<b>Spoolmate 200</b> 300497	160 A at 60% duty cycle	1.8–22.2 m/min. (70–875 ipm)	<b>Aluminum</b> 0.8–0.9 mm (.030–.035 in.) <b>Solid steel</b> 0.6–0.9 mm (.023–.035 in.) <b>Stainless</b> 0.6–0.9 mm (.023–.035 in.)	102 mm (4 in.)	H: 229 mm (9 in.) W: 64 mm (2.5 in.) L: 368 mm (14.5 in.)	5 kg (11 lb.)
<b>Spoolmate 3035</b> 195016	150 A at 60% duty cycle, 200 A at 60% duty cycle with optional heavy-duty head tube	2.9–18.1 m/min. (115–715 ipm)	<b>Aluminum</b> 0.8–0.9 mm (.030–.035 in.) <b>Solid steel</b> 0.6–0.9 mm (.023–.035 in.) <b>Stainless</b> 0.6–0.9 mm (.023–.035 in.)	102 mm (4 in.)	H: 291 mm (11.5 in.) W: 57 mm (2.25 in.) L: 203 mm (8 in.)	4.1 kg (9.1 lb.)





## Spoolmatic® Spool Guns

Portable, aluminum wire feeder for industrial applications.



Spoolmatic

**PORTABLE!**



Spoolmatic Pro

### Spoolmatic See literature M/1.73

**Integrated spool canister** rotates 180 degrees for operator flexibility and comfort.

**Available in 4.6 or 9 m (15 or 30 ft.) cable lengths**, providing flexibility to be used in the shop and in the field.

**Two-stage trigger with built-in gas valve** allows for gas preflow, and eliminates the need to purge long gas lines.

**Wire feed speed adjustment on the gun handle and reversible drive rolls** save time and money.

**Quick-change, single-turn contact tip** provides excellent performance and is easy to replace.

### Spoolmatic Pro (additional features) See literature M/1.76

**Wire tension settings.** 4000- or 5000-specific tension settings ensure the very best wire feeding performance and arc consistency.

**More durable motor and drive design** improves feedability and arc consistency while helping reduce downtime and maintenance costs.

**Easy access to drive assembly and removable toolless head tube** reduce service time by allowing a means of changing drive rolls and head tube, or performing routine maintenance, without disassembly of gun.

**Easy-to-rotate, self-seating head tube** allows for better access into tight spots, preventing leaks and providing excellent current transfer. Head tubes are common with the XR-Aluma-Pro™ and XR™-Pistol-Pro guns.

**Head tube options in several different lengths and bend configurations** are available for when a standard head tube doesn't fit the application.

\*Spoolmatic Pro requires gun wire kit (230708) to run 1.6 mm (1/16 in.) wire.

Industrial Use with CC, CV, DC power sources.

#### Processes

- MIG (GMAW) with aluminum and other soft alloy wires
- MIG (GMAW) with solid wires
- Pulsed MIG (GMAW-P) with pulsing power source

#### Suggested power sources

##### For Spoolmatic (non-Pro model only)

- Millermatic® 252
- Millermatic® 255
- Millermatic® 355
- Multimatic® 235
- Multimatic® 255

##### For both Spoolmatic models

- Bobcat™ 200 Air Pak™
- Bobcat™ 265
- Trailblazer® Series

These power sources require WC-24 control (137549)

- AlumaPower™ MPa
- XMT® Series
- Big Blue® Series (not compatible with Big Blue 450 Duo CST)

#### Most popular accessories

- WC-115A 137546
- WC-115A with contactor 137546011
- WC-24 137549

Model/Stock Number	Welding Current Rating	Wire Feed Speed	Wire Type and Diameter Capacity	Maximum Spool Size Capacity	Dimensions	Gun Only Net Weight
<b>Spoolmatic</b> 195156 4.5 m (15 ft.) cable 130831 9 m (30 ft.) cable	200 A at 100% duty cycle	1.8–22.2 m/min. (70–875 ipm) Wire speed dependent on control box or power source used	<b>Aluminum*</b> 0.8–1.6 mm (.030–1/16 in.) <b>Hard wire</b> 0.8–1.1 mm (.030–.045 in.)	102 mm (4 in.)	H: 260 mm (10.25 in.) W: 64 mm (2.5 in.) L: 384 mm (15.125 in.)	1.3 kg (2.9 lb.)
<b>Spoolmatic Pro</b> 301147 4.5 m (15 ft.) cable 301148 9 m (30 ft.) cable	200 A at 100% duty cycle	1.8–23 m/min. (70–900 ipm) Wire speed dependent on control box or power source used			H: 273 mm (10.75 in.) W: 64 mm (2.5 in.) L: 390 mm (15.375 in.)	1.4 kg (3.0 lb.)

Miller recommends



Hobart® aluminum filler metals — wire and cut lengths — have been designed to provide the best performance for the best welds. These products are backed by the deep industry knowledge of Hobart welding specialists who can help customers find the right aluminum filler metal solution. Every time. No matter how challenging the application.

Visit [HobartBrothers.com](http://HobartBrothers.com) or your local distributor to learn more.

Questions? Hobart is here to help.



## XR™ Push-Pull Guns

XR-Aluma-Pro and XR-Pistol guns work in conjunction with an XR Control, XR-AlumaFeed or select Millermatic machines to provide the best solution for push-pull applications.



XR-Aluma-Pro Lite



XR-Aluma-Pro

**PORTABLE!**

**Threaded quick-change 360-degree rotatable head tubes are available in different bends and lengths** for even those hard-to-reach welds. Over 30 different styles to fit your application and welder's preference.

**Wire tension settings (except XR-Pistol).** 4000- or 5000-specific tension settings ensure the very best wire feeding performance and arc consistency.

**Heavy-duty construction.** All internal components are designed to provide long lasting performance and feeding precision.

### XR-Aluma-Pro™ Lite See literature M/1.75

**Lightest weight gooseneck-style gun features rear trigger that allows access to hard-to-reach welds.**

### XR-Aluma-Pro™ See literature M/1.71

**Robust professional-grade gun has the highest duty cycle rating in its class.**

**Easy access to drive assembly and removable toolless head tube** reduce service time by allowing a means of changing drive rolls and head tube, or performing routine maintenance, without disassembly of gun.

### XR™-Pistol See literature M/1.73

**Reliable, cost-effective gun for light- to medium-industrial applications.**

### XR™-Pistol-Pro See literature M/1.74

**Exceptional aluminum welding results for heavy-industrial applications.**

**Most durable motor and drive design** improves feedability and arc consistency while helping reduce downtime and maintenance costs.

**Easy access to drive assembly and removable toolless head tube** reduce service time by allowing a means of changing drive rolls and head tube, or performing routine maintenance, without disassembly of gun.



XR-Pistol



XR-Pistol-Pro

\*Dependent on control box or Millermatic used. \*\*Requires wire kit (230708) to run 1.6 mm (1/16 in.) wire.

**Industrial** ● XR-Aluma-Pro Lite  
**Heavy industrial** ● XR-Aluma-Pro and all Pistol models

**CC CV DC** Use with CC/CV, DC power sources.

#### Processes

- MIG (GMAW) with aluminum wire (capable of other wires with optional solid wire kits)
- Pulsed MIG (GMAW-P) with pulsing power source

#### Suggested feeders/controls

- XR-AlumaFeed® SuitCase®

#### Suggested power sources

- Millermatic® 255 (XR-Aluma-Pro Lite, XR-Aluma-Pro and XR-Pistol-Pro guns only)
- Millermatic® 355 (XR-Aluma-Pro Lite, XR-Aluma-Pro and XR-Pistol-Pro guns only)
- Multimatic® 255 (XR-Aluma-Pro Lite, XR-Aluma-Pro and XR-Pistol-Pro guns only)

*These power sources require an XR-AlumaFeed SuitCase*

- AlumaPower™ MPa
- Deltaweld® 350/500 (14-pin receptacle models only)
- XMT® Series
- Trailblazer® Series

#### Most popular accessories

- Solid Wire Liner Kit 198377

Model	Cable Length				Welding Current Rating	Wire Feed Speed*	Wire Type and Diameter Capacity	Dimensions	Gun Only Net Weight
	4.6 m (15 ft.)	7.6 m (25 ft.)	9 m (30 ft.)	10.6 m (35 ft.)					
XR-Aluma-Pro Lite (Air-cooled)	—	300948	—	—	175 A at 60% duty cycle	1.8–23 m/min. (70–900 ipm)	Aluminum 0.8–1.2 mm (.030–.047 in.)	H: 102 mm (4 in.) W: 48 mm (1.9 in.) L: 381 mm (15 in.)	0.9 kg (2.0 lb.)
XR-Aluma-Pro (Air-cooled)	301568	301569	—	301570	300 A at 100% duty cycle	1.8–23 m/min. (70–900 ipm)	Aluminum** 0.8–1.6 mm (.030–1/16 in.)	H: 127 mm (5 in.) W: 64 mm (2.5 in.) L: 432 mm (17 in.)	1.1 kg (2.5 lb.)
XR-Aluma-Pro (Water-cooled)	301571, CE	301572, CE	—	301573, CE	400 A at 100% duty cycle				1.3 kg (2.9 lb.)
XR-Pistol (Air-cooled)	198127, CE	—	198128, CE	—	200 A at 100% duty cycle	1.8–22.2 m/min. (70–875 ipm)	Aluminum 0.8–1.6 mm (.030–1/16 in.)	H: 187 mm (7.375 in.) W: 48 mm (1.875 in.) L: 270 mm (10.625 in.)	1 kg (2.2 lb.)
XR-Pistol (Water-cooled)	198129, CE	—	198130, CE	—	400 A at 100% duty cycle				1.1 kg (2.4 lb.)
XR-Pistol-Pro (Air-cooled)	300782	300783	—	300784	200 A at 100% duty cycle	1.8–23 m/min. (70–900 ipm)	Aluminum** 0.8–1.6 mm (.030–1/16 in.)		1 kg (2.2 lb.)
XR-Pistol-Pro (Water-cooled)	300786	300787	—	300788	400 A at 100% duty cycle				1.1 kg (2.4 lb.)



## Multimatic® 215

See literature DC/12.59



Multi-voltage plug (MVP™) allows connection to common 120- and 240-volt power receptacles without the use of any tools—simply choose the plug that fits the receptacle and connect to the power cord.

### Welding Capability

Max. 9.5 mm (3/8 in.)	Max. 9.5 mm (3/8 in.)
MIG Mild Steel	MIG Aluminum
Min. 0.6 mm (24 ga.)	Min. 1.2 mm (18 ga.)
Max. 4.8 mm (3/16 in.)	Max. 9.5 mm (3/8 in.)
TIG Mild Steel	Stick Mild Steel
Min. 0.6 mm (24 ga.)	Min. 1.5 mm (16 ga.)

Aluminum welding uses optional Spoolmate 100 and 4000 series aluminum wire **OR** Spoolmate 150 and either 4000 or 5000 series aluminum wire. TIG welding uses optional TIG contractor kit.

### Intuitive color LCD interface

makes it quick and easy to adjust parameters.



**Auto-Set™ Elite** can be used on multiple materials and multiple processes with the ability to fine-tune your settings. Easy to set up and use!

**Weighing only 17 kg (38 lb.)**, this lightweight MIG, stick and TIG welder provides portability on the job.

**Angled cast-aluminum drive system** with calibrated tension knob creates consistent feeding and easy setup.

**Excellent arc characteristics!** Positive arc starts and an extremely stable arc with minimal spatter.

**Quick Select™ drive roll** makes setup quicker by offering three grooves – two for different size solid wire and a third for flux-cored wire.

**Auto Spool Gun Detect™** automatically detects when a MIG gun or spool gun is connected, eliminating the need for a switch.

**Fan-On-Demand™** cooling system only operates when needed, reducing power consumption and keeping internal components cleaner.

**Thermal overload protection** shuts down unit if airflow is blocked or duty cycle is exceeded. Automatically resets when unit cools.

**Uses 102 or 203 mm (4- or 8-in.) spools.**

Light industrial

### Processes

- MIG (GMAW) ▪ Flux-cored (FCAW)
- DC stick (SMAW) ▪ DC TIG (DC GTAW)

### Comes complete with

- 3 m (10 ft.) 100-amp MDX™-100 MIG gun with AccuLock™ MDX™ consumables
- 4 m (13 ft.) cable with electrode holder and 25 mm Dinse-style connector
- 3 m (10 ft.) work cable with clamp and 25 mm Dinse-style connector
- 2 m (6.5 ft.) power cord with MVP plugs for 120 V and 240 V
- Quick Select™ drive roll for 0.6 mm (.024 in.) or 0.8/0.9 mm (.030/.035 in.) solid wire, and 0.8/0.9 mm (.030/.035 in.) flux-cored wire

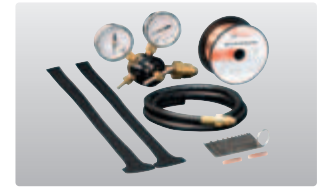

- Flow gauge regulator and gas hose for argon or AR/CO<sub>2</sub> mix, extra MDX contact tips, Hobart® spool of 0.8 mm (.030 in.) solid wire, hook-and-loop cord wraps, information/settings chart and material thickness gauge (229895)

### Most popular accessories

- Spoolmate™ Spool Guns  
300371 Spoolmate 100  
301272 Spoolmate 150
- Running Gear/Cylinder Rack 301239
- Protective Cover 301262
- TIG Contractor Kit 301337

Stock Number  
907693

Welding Mode/Process	Input Power	Amperage Range	Rated Output	Amps Input at Rated Output, 50/60 Hz				Wire Feed Speed	Max. Open-Circuit Voltage	Dimensions	Net Weight
				120 V	240 V	KVA	KW				
CV: MIG/flux-cored	120 V	30-125	110 A at 19.5 V, 60% duty cycle	23.0	—	2.8	2.8	1.5-15.2 m/min. (60-600 ipm)	58 VDC	H: 318 mm (12.5 in.) W: 286 mm (11.25 in.) D: 521 mm (20.5 in.)	
	240 V	30-230	200 A at 24 V, 20% duty cycle	—	25.8	6.2	6.2				
			150 A at 21.5 V, 40% duty cycle	—	16.7	4.0	4.0				
CC: TIG	120 V	20-150	140 A at 15.6 V, 40% duty cycle	24.6	—	3.0	3.0	—	58 VDC	D: 521 mm (20.5 in.)	
	240 V	20-210	190 A at 17.6 V, 20% duty cycle	—	18.0	6.7	6.7				
CC: Stick	120 V	30-100	90 A at 23.6 V, 40% duty cycle	22.7	—	2.7	2.7	—	58 VDC	D: 521 mm (20.5 in.)	
	240 V	30-200	190 A at 27.6 V, 20% duty cycle	—	27.0	6.5	6.5				





# MULTIPROCESS

## Multimatic® 220 AC/DC

See literature AD/9.0



Multi-voltage plug (MVP™) allows connection to common 120- and 240-volt power receptacles without the use of any tools – simply choose the plug that fits the receptacle and connect to the power cord.



### Welding Capability

Max. 9.5 mm (3/8 in.)	Max. 9.5 mm (3/8 in.)
MIG Mild Steel	MIG Aluminum
Min. 0.6 mm (24 ga.)	Min. 1.2 mm (18 ga.)
Max. 6.4 mm (1/4 in.)	Max. 6.4 mm (1/4 in.)
TIG Mild Steel	TIG Aluminum
Min. 0.6 mm (24 ga.)	Min. 0.6 mm (24 ga.)
Max. 9.5 mm (3/8 in.)	
Stick Mild Steel	
Min. 1.5 mm (16 ga.)	

MIG aluminum welding uses optional Spoolmate 100 and 4000 series aluminum wire OR Spoolmate 150 and either 4000 or 5000 series aluminum wire.

**All in one.** Comes equipped with all accessories to MIG, stick, AC and DC TIG weld with one machine – unlike other machines where you need to purchase additional accessories.

**Intuitive color LCD interface** makes it quick and easy to adjust parameters.



**Weighing only 25.3 kg (56 lb.),** this lightweight MIG, stick and AC/DC TIG welder provides portability on the job.

**Innovative QuickTech™** makes setup and changing processes easy.

- Automatically determines the polarity. Work is always connected to the bottom right receptacle. MIG gun and TIG torch can stay connected at the same time.
- Automatically switches to the right process. Just hit the trigger or the foot control and the machine automatically changes, eliminating the need to manually change processes.
- Automatically recalls the settings from the last process used.

**Auto-Set™ Elite** can be used on multiple materials and multiple processes with the ability to fine-tune your settings. Easy to set up and use!

**Pro-Set™ (TIG/stick)** eliminates the guesswork when setting weld parameters. Use Pro-Set when you want the speed, convenience and confidence of preset controls.

**Two shielding gas connections (one for MIG gas and one for TIG gas)** so both gases can be left connected to the machine – no switching needed.

**Manual mode offers additional TIG adjustments** for increased control including AC balance, AC frequency and DC pulsing.

**TIG high-frequency (HF) arc starting** for non-contact arc initiation, reducing tungsten and material contamination.

**Uses 102 or 203 mm (4- or 8-in.) spools.**

Light Industrial ● CC CV AC DC 1 Phase

### Processes

- MIG (GMAW) = Flux-cored (FCAW)
- DC stick (SMAW) = AC/DC TIG (GTAW)
- Pulsed TIG (GTAW-P)

### Comes complete with

- 3 m (10 ft.) 100-amp MDX™-100 MIG gun with AccuLock™ MDX™ consumables
- 4 m (13 ft.) cable with electrode holder and 25 mm Dinse-style connector
- 3.8 m (12.5 ft.) Weldcraft™ A-150 (WP-17) TIG torch with 25 mm Dinse-style connector
- 3 m (10 ft.) work cable with clamp and 25 mm Dinse-style connector
- 2 m (6.5 ft.) power cord with MVP plugs for 120 V and 240 V
- RFCS-14 HD foot control with 6 m (20 ft.) cord
- Quick Select™ drive roll for 0.6 mm (.024 in.) or 0.8/0.9 mm (.030/.035 in.) solid wire, and 0.8/0.9 mm (.030/.035 in.) flux-cored wire
- Two flow gauge regulators and gas hoses for argon or AR/CO<sub>2</sub> mix, extra contact tips, Hobart® spool of 0.8 mm (.030 in.) solid wire, AK2C TIG torch accessory kit, hook-and-loop cord wraps and material thickness gauge (229895)

### Most popular accessories

- Spoolmate™ Spool Guns
  - 300371 Spoolmate 100
  - 301272 Spoolmate 150
- Protective Cover 301524
- Wireless Remote Foot Control 301580

Stock Number 907757	Welding Mode/Process	Input Power	Amperage Range	Rated Output	Amps Input at Rated Output, 50/60 Hz				Wire Feed Speed	Max. Open-Circuit Voltage	Dimensions	Net Weight
					120 V	240 V	KVA	KW				
CV: MIG/flux-cored		120 V	30-125	105 A at 19.2 V, 60% duty cycle	23.3	–	2.8	2.8	1.5-15.2 m/min. (60-600 ipm)	45 VDC	H: 445 mm (17.5 in.) W: 286 mm (11.25 in.) D: 546 mm (21.5 in.)	25.3 kg (56 lb.)
		240 V	30-230	200 A at 24 V, 20% duty cycle	–	27.2	4.8	4.8				
				170 A at 21.5 V, 40% duty cycle	–	21.5	3.8	3.8				
CC: TIG		120 V	20-140	130 A at 15.2 V, 40% duty cycle	24.0	–	2.9	2.9	–	46 VDC		
		240 V	20-210	210 A at 18.4 V, 20% duty cycle	–	22.4	5.4	5.4				
CC: Stick		120 V	30-90	90 A at 23.6 V, 40% duty cycle	24.5	–	2.9	2.9				
		240 V	30-200	200 A at 28.4 V, 15% duty cycle	–	31.3	7.5	7.5				



## Multimatic® 235

See literature DC/14.0

Industrial ● CC CV DC 1 Phase



Multimatic 235 with running gear package shown.



### Welding Capability

Max. 9.5 mm (3/8 in.)	Max. 9.5 mm (3/8 in.)
<b>Mild Steel</b>	<b>Aluminum</b>
Min. 0.6 mm (24 ga.)	Min. 1.2 mm (18 ga.)
Max. 6.4 mm (1/4 in.)	Max. 9.5 mm (3/8 in.)
<b>TIG Mild Steel</b>	<b>Stick Mild Steel</b>
Min. 0.6 mm (24 ga.)	Min. 1.5 mm (16 ga.)

Aluminum welding uses optional spool guns.  
TIG welding uses optional Multimatic 235/255 TIG kit.

### Processes

- MIG (GMAW) ▪ Flux-cored (FCAW)
- DC stick (SMAW)
- DC Lift-Arc™ TIG (GTAW)
- Pulsed TIG (GTAW-P)

### Comes complete with

- 4.5 m (15 ft.) 250-amp MDX™-250 MIG gun with AccuLock™ MDX™ consumables
- 3 m (10 ft.) cable with electrode holder
- 3 m (10 ft.) work cable with clamp
- 2.1 m (7 ft.) industrial power cord
- Two factory-installed gas solenoids
- Flow gauge regulator and gas hose for argon or AR/CO<sub>2</sub> mix
- Chain to secure gas cylinder
- 0.8/0.9 mm (.030/.035 in.) reversible V-groove drive rolls
- Extra contact tips and material thickness gauge (229895)

### Most popular accessories

- Spoolmate™ Spool Guns
  - 300371 Spoolmate 100
  - 301272 Spoolmate 150
  - 300497 Spoolmate 200
- Spoolmatic® Spool Gun (non-Pro gun only)
- EZ-Latch™ Single Cylinder Running Gear 301449
- EZ-Latch™ Dual Cylinder Rack with Elevated Gun and Cable Rack 301481
  - Converts an EZ-Latch™ Single Cylinder Running Gear into a Dual Cylinder Rack Running Gear
- Protective Cover 301521
- Multimatic 235/255 TIG Kit 301518
- 10-Pin to 14-Pin Adapter Cord 301545
- Wireless Remote Foot Control 300429



**Easy-to-understand interface** with 109 mm (4.3 in.) color LCD display and intuitive connection setup images.

**Weighing only 28.6 kg (63 lb.) (machine only)**, this lightweight MIG, stick and DC TIG welder provides portability on the job.

**Compatible with Spoolmate™ 100, 150 and 200, and Spoolmatic 15A and 30A spool guns** to offer a variety of aluminum welding solutions.

**EXCLUSIVE! Auto-Gun Detect™** automatically adjusts voltage, wire speed and timers for faster switching between MIG and spool guns.

**Heavy-duty aluminum two-drive-roll system.**

**Uses 102, 203 or 305 mm (4, 8 or 12 in.) spools.**

**Auto-Set™ Elite** offers predefined weld settings to increase ease of use and ensure that the job is done right for operators of all skill levels.

- Available for MIG, stick and DC TIG processes with the ability to fine-tune your settings
- Set weld parameters by:
  - MIG – selecting wire and gas type, wire diameter and material thickness
  - Stick – selecting electrode type, electrode diameter and material thickness
  - DC Lift-Arc™ TIG – selecting remote on/off, tungsten diameter and material thickness

**Pro-Set™ (TIG/stick)** eliminates the guesswork when setting weld parameters. Use Pro-Set when you want the speed, convenience and confidence of preset controls.

**Two shielding gas connections (one for MIG gas and one for TIG gas)** so both gases can be left connected to the machine – no switching needed.

**Manual mode offers additional stick and TIG adjustments** for increased control including adjustable DIG control for stick and 0.1-150 pulses per second for DC pulsed TIG.

**Fan-On-Demand™** cooling system only operates when needed, reducing power consumption and keeping internal components cleaner.

\*Input voltage range for the Multimatic 235 is 204-276 V.

Stock Number 907780 240 V	Welding Mode/Process	Amperage Range	Rated Output	Amps Input at Rated Output, 50/60 Hz 240 V*			Wire Feed Speed	Max. Open-Circuit Voltage	Power Source Dimensions	Power Source Net Weight
				KVA	KW					
	CV: MIG/flux-cored	30-235	170 A at 22.5 V, 60% duty cycle	20.0	5.0	4.9	1.5-15.2 m/min. (60-600 ipm)	54 VDC	H: 489 mm (19.24 in.) W: 349 mm (13.75 in.) D: 616 mm (24.25 in.)	29 kg (63 lb.)
	CC: Stick	30-200	150 A at 26 V, 60% duty cycle	20.2	5.0	4.8	–			
	CC: DC TIG	20-210	180 A at 17.2 V, 60% duty cycle	17.0	4.2	4.1	–			



# MULTIPROCESS

## Multimatic® 255

See literature DC/12.9



Multimatic 255 with running gear

### Welding Capability

Max. 13 mm (1/2 in.)	Max. 13 mm (1/2 in.)
Mild Steel Min. 0.8 mm (22 ga.) Max. 9.5 mm (3/8 in.)	Aluminum Min. 1.2 mm (18 ga.) Max. 7.9 mm (5/16 in.)
TIG Mild Steel Min. 0.6 mm (24 ga.)	Stick Mild Steel Min. 1.5 mm (16 ga.)

Aluminum welding uses optional XR-Aluma-Pro push-pull gun. TIG welding uses optional Multimatic 255 TIG kit.



With MDX Series MIG gun.



**Easy-to-understand interface with 7-inch color LCD display** ensures proper machine setup and parameter selection, reducing setup time and increasing weld time.

- Quick-access process and weld mode backlit buttons across the top illuminate when active
- Soft-key buttons below the display change function depending on which screen is displayed – makes setup or change quick, easy and intuitive
- Large text for easier readability
- Intuitive connection setup images
- Full troubleshooting descriptions versus help errors and look up codes

**AUTO-LINE TECHNOLOGY** Allows for any input voltage hookup (208–575 V, single-phase) with no manual linking, providing convenience in any job setting. Ideal solution for dirty or unreliable power.

**Auto-Set™ Elite** offers predefined weld settings to increase ease of use and ensure that the job is done right for operators of all skill levels.

- Available for MIG, pulsed MIG, stick and DC TIG processes with the ability to fine-tune your settings
- Set weld parameters by:  
MIG – selecting wire and gas type, wire diameter and material thickness  
Stick – selecting electrode type, electrode diameter and material thickness  
DC Lift-Arc™ TIG – selecting remote on/off, tungsten diameter and material thickness

**Built-in pulsed MIG programs.** All programmed information is restored after each power up – aluminum/steel/stainless steel.

**Program mode** allows easy save and recall of favorite weld settings. Save up to four programs for each process. Delivers more productivity and consistent quality while minimizing supervisor intervention.

**EXCLUSIVE! Auto-Gun Detect™** automatically adjusts voltage, wire speed and timers for faster switching between MIG, push-pull and spool guns.

**Heavy-duty aluminum two-drive-roll system.**

**Fan-On-Demand™** cooling system only operates when needed, reducing power consumption and keeping internal components cleaner.

Industrial ● CC CV DC 1 Phase

### Processes

- MIG (GMAW) • Flux-cored (FCAW)
- Pulsed MIG (GMAW-P)
- DC stick (SMAW)
- DC Lift-Arc™ TIG (GTAW)
- Pulsed TIG (GTAW-P)

### Multimatic 255 comes complete with

- 4.5 m (15 ft.) 250-amp MDX™-250 MIG gun with Bernard® AccuLock™ S consumables
- 3 m (10 ft.) cable with electrode holder
- 3 m (10 ft.) work cable with clamp
- 3 m (10 ft.) industrial power cord
- Factory-installed gas solenoid
- Flow gauge regulator and gas hose for argon or AR/CO<sub>2</sub> mix
- Chain to secure gas cylinder
- .035/.045 in. reversible V-groove drive rolls
- Extra contact tips and material thickness gauge (229895)

### Most popular accessories

- MDX™-250 EZ-Select™ MIG Gun 1770047
- Spoolmatic® Spool Guns
- XR-Aluma-Pro™ Air-Cooled Push-Pull Guns
- EZ-Latch™ Single Cylinder Running Gear 301449
- EZ-Latch™ Dual Cylinder Rack with Elevated Gun and Cable Rack 301481
- Protective Cover 301521
- Multimatic 255 TIG Kit 301518
- 10-Pin to 14-Pin Adapter Cord 273873

Stock Number 907728 208-575 V	Welding Mode/Process	Amperage Range	Rated Output	Amps Input at Rated Output, 50/60 Hz				Wire Feed Speed	Max. Open-Circuit Voltage	Power Source Dimensions	Power Source Net Weight		
				208 V	240 V	460 V	575 V					KVA	KW
	CV: MIG/flux-cored	20-350	230 A at 25.5 V, 60% duty cycle	34.7	29.7	17.1	14.3	8.2	8.2	1.3-20 m/min. (50-800 ipm)	81 VDC	H: 489 mm (19.24 in.) W: 349 mm (13.75 in.) D: 667 mm (26.25 in.)	38 kg (84 lb.)
	CC: Stick	30-275	200 A at 28 V, 60% duty cycle	33.5	29	16.4	13.6	7.8	7.8	–			
	CC: DC TIG	5-275	275 A at 21 V, 60% duty cycle	34.1	29.9	17	14.1	8.1	8.1				





## Maxstar® 280 Multiprocess Dynasty® 300 Multiprocess

See literature DC/35.5 (Maxstar) and AD/4.97 (Dynasty)

**Multiprocess performance in a portable package. Designed for industrial applications that require a versatile solution with superior arc performance.**



**ArcReach® SuitCase® feeder** paired with the CV output of the Maxstar or Dynasty power source gives this unit MIG process capabilities.

*Note: Maxstar and Dynasty are not capable of ArcReach control.*



Maxstar 280 Multiprocess (far left) and Dynasty 300 Multiprocess shown with ArcReach SuitCase 12

**AUTO-LINE TECHNOLOGY** Allows for any input voltage hook-up (Maxstar: 208-575 V, Dynasty: 208-600 V) with no manual linking, providing convenience in any job setting. Ideal solution for dirty or unreliable power.

**Blue Lightning™** high-frequency (HF) arc starter for non-contact arc initiation. Provides more consistent arc starts and greater reliability compared to traditional HF arc starters.

**Pulsed TIG** can be used to increase puddle agitation, arc stability and travel speeds while reducing heat input and distortion.

**QUIETPULSE™** QuietPulse is activated by changing the waveshape for DC pulse welding to create a slower, more fluid transition between the background and peak amperage, resulting in lower audible noise. Machines manufactured after serial number ND040985L include QuietPulse. Those manufactured before can be updated with QuietPulse™ Expansion Memory Card (301790).

**Fan-On-Demand™** cooling system only operates when needed, reducing power consumption and keeping internal components cleaner.

**Cooler-On-Demand™** feature operates the auxiliary cooling system only when needed. Reduces noise, energy use, and airborne contaminants pulled through the cooler.



Dynasty 300 Multiprocess shown with accessories.

\*Refer to owner's manual for complete ratings.  
\*\*Sense voltage for low OCV stick and Lift-Arc™ TIG.

**Industrial**  
CV AC 3 1 Maxstar is DC only  
DC Phase Phase

### Processes

- AC<sup>1</sup>/DC TIG (GTAW) ■ Pulsed TIG (GTAW-P)
- MIG (GMAW)<sup>2</sup> ■ Flux-cored (FCAW)<sup>2</sup>
- Stick (SMAW) ■ Air carbon arc (CAC-A)

<sup>1</sup> Dynasty model only.

<sup>2</sup> With ArcReach SuitCase wire feeder.

### Comes with

- 2.4 m (8 ft.) power cord (no plug)
- Two 50 mm Dinse-style connectors
- Two Dinse/Tweco® adapters
- 2.4 m (8 ft.) weld cable with Tweco®-style connectors to power feeder

### TIGRunner® includes above plus

- Small Runner™ Cart
- Coolmate™ 1.3

### Contractor package includes above (except TIGRunner) plus

- Contractor kit with A-200 TIG torch and RFCS-14 HD foot control (301549)
- ArcReach® SuitCase® 12 with two 0.9/1.2 mm (.035/.045 in.) reversible V-groove drive rolls
- Bernard® BTB Gun 300 A with AccuLock™ consumables

### Most popular accessories

- ArcReach® SuitCase® Feeders
- Small Runner™ Cart 301615
- Coolmate™ 1.3 301616
- Contractor Kits
  - 301311 w/RCCS-14 finger control
  - 301309 w/RFCS-14 HD foot control
- Weldcraft™ Water-Cooled Torch Kits
  - 300185 W-250 (WP-20)
  - 300990 W-280 (WP-280)
  - 301268 W-375
- Remote Controls

	Model/Stock Number	Welding Process	Input Power	Welding Amp Range	Rated Output at 60% Duty Cycle	Amps Input at Rated Load Output, 50/60 Hz						Max. Open-Circuit Voltage	Power Source Dimensions	Power Source Net Weight			
						208 V	230 V	240 V	400 V	460 V	575 V	600 V	KVA	KW			
DC Maxstar	Maxstar 280 Multiprocess 907552001 Power source only	TIG	3-phase	1-280	250 A at 20 V	21	19	-	11	9	7	-	7.6	7.3	60 VDC (11 VDC**)	H: 346 mm (13.6 in.) W: 219 mm (8.6 in.) D: 569 mm (22.5 in.)	21.3 kg (47 lb.)
			1-phase	1-280	250 A at 20 V	35	32	-	18	16	13	-	7.3	7.1			
		Stick	3-phase	5-280	250 A at 30 V	*	*	-	14	13	10	-	9.9	9.6			
			1-phase	5-280	180 A at 27.2 V	32	29	-	*	*	*	-	6.7	6.5			
		MIG/ flux-cored	3-phase	5-280	250 A at 26.5 V	*	*	-	13	11	9	-	9.2	8.9			
			1-phase	5-280	200 A at 24 V	31	29	-	*	*	*	-	6.5	6.3			
AC/DC Dynasty	Dynasty 300 Multiprocess 907819 Power source only 907819002 Power source only, CE 907819001 TIGRunner 907819003 TIGRunner, CE	TIG	3-phase	2-300 (AC) 1-300 (DC)	250 A at 20 V	19	-	16	10	8	-	7	7.5	6.6	60 VDC (11 VDC**)	H: 352 mm (13.88 in.) W: 216 mm (8.5 in.) D: 555 mm (21.88 in.)	25 kg (55 lb.)
			1-phase	2-300 (AC) 1-300 (DC)	250 A at 20 V	33	-	29	17	15	-	11	6.7	6.7			
		Stick	3-phase	5-300	250 A at 30 V	*	-	*	14	12	-	9	9.8	9.1			
			1-phase	5-300	200 A at 27.2 V	35	-	31	*	*	-	*	9.3	9.2			
		MIG/ flux-cored	3-phase	5-300	250 A at 26.5 V	*	-	*	12	11	-	9	8.9	8.1			
			1-phase	5-300	200 A at 24 V	31	-	27	*	*	-	*	6.2	6.1			



## XMT® Series

Portability and excellent multiprocess arc performance make the XMT family the most popular in the industry. With many models to choose from the XMT family has the right solution for your business.



### Input power choices

**AUTO-LINE TECHNOLOGY** (350/425 models) allows for any input voltage hookup (230–575 V, three-phase) with no manual linking, providing convenience in any job setting. Ideal solution for dirty or unreliable input power.

**Standard hookup** (450 models). Available as 400 V, three-phase.

### Advanced features for the professional welder

**Adaptive Hot Start™** makes starting stick electrodes easy without creating an inclusion.

**Infinite arc control** available in the stick and wire modes for easier fine tuning of tough-to-weld materials and out-of-position applications.

**Lift-Arc™** provides arc starting that minimizes contamination of the electrode and without the use of high frequency.

**Insight Core™ Welding Intelligence™ system.** XMT 14-pin models are Insight Core capable to monitor weld voltage, amperage, and arc-time and percentage.

### Reliability

**Wind Tunnel Technology™** Air flow that protects internal components, greatly improving reliability.

**Fan-On-Demand™** cooling system operates only when needed, reducing noise, energy use and amount of contaminants pulled through machine.

### Welder friendly control panel

**Process selector switch** reduces the number of control setup combinations without reducing any features.

**Ultra-tough, polycarbonate-blended cover** protects front controls from damage.

**Large, dual digital meters** are easy to view and presettable to ease setting weld output.

### Output connector choices

**Dinse-style weld disconnects** (350/425 models) provide high-quality weld cable connections. Machines come with two Dinse connectors.

**Weld studs** (450 models).

**14-pin receptacle** provides a quick, direct connection to Miller® wire feeders. Capable of remote voltage control.

## Choose the Right XMT

	350 Amp			450 Amp	
	XMT 350 CC/CV	XMT 350 MPa	XMT 425 CC/CV	XMT 450 CC/CV	XMT 450 MPa
Input Power	3-phase		3-phase	3-phase	
Primary Operating Range	Auto-Line (230–575 V)		Auto-Line (230–575 V)	400 V	
Weld Output	350 A at 34 VDC (3-phase input power at 60% duty cycle)		425 A at 27 VDC (3-phase input power at 30% duty cycle)	UPGRADE	450 A at 38 VDC (3-phase input power at 100% duty cycle)
Carbon Arc Gouging	Rated: 6 mm		Rated: 6 mm	UPGRADE	Rated: 7.9 mm
Net Weight	36.3 kg (80 lb.)		36.3 kg (80 lb.)	55.3 kg (122 lb.)	
Output Connector	Dinse		Dinse	1/2 in. stud	
Pulsed MIG	–	UPGRADE Yes	–	UPGRADE Yes	–
14-pin Compliant	Yes		Yes	Yes	
Insight Core Capable (requires Insight Core 14-pin module)	Yes		Yes	Yes	



## XMT® 350 CC/CV, 425 CC/CV and 450 CC/CV

See literature DC/18.93 (350), EX/18 (425) and DC/18.94 (450)

**Flexibility and simplicity make this the most popular model. It has the core multiprocess capabilities along with the flexibility of a 14-pin for spool guns, feeders, and remote controls.**

**Stronger weld output for increased capabilities.** XMT 350 provides 24 percent more output than the 304 model for larger wires and stick electrodes. XMT 450 provides 43 percent more output for carbon arc gouging.



## XMT® 350 MPa and 450 MPa

See literature DC/18.93 (350) and DC/18.94 (450)

**Built-in pulse programs for manufacturing and fabrication applications that have benefits for standard steels, high-strength steels and aluminum.**

**Pulse programs** provide reduced heat affected zone, weld in all positions, great for thick-to-thin metal, good gap filling ability and faster travel speeds and deposition.

**SharpArc®** controls the arc in pulsed MIG mode and gives total control over the arc cone shape, puddle fluidity and bead profile.

### Additional features when using a 70 Series MPa Plus feeder or XR-AlumaFeed® SuitCase® feeder.

#### Synergic pulsed MIG.

As you increase/decrease the wire feed speed, the pulse parameters increase/decrease, matching the right amount of power output to match the wire speed, eliminating the need to make additional adjustments.



**Profile Pulse™** provides TIG appearance with MIG simplicity and productivity. Achieve “stacked dimes”



without gun manipulation. Profile Pulse frequency can be changed to increase or decrease the spacing between the ripple pattern to achieve the desired weld appearance.

**Added capabilities with Insight Core.™** When using an MPa Plus feeder, wire deposition is added to the Insight Core capabilities.

Heavy industrial **DC 3** Phase

#### Processes

- MIG (GMAW) ▪ Pulsed MIG (GMAW-P)\*
- Stick (SMAW) ▪ TIG (GTAW)
- Flux-cored (FCAW)
- Air carbon arc cutting and gouging (CAC-A) (carbons – 350/425: 6 mm, 450: 8 mm)

\*Only XMT MPa models.

#### Most popular accessories

- XR-AlumaFeed®
- SuitCase® Feeders
- 70 Series Feeders
- XR™ Control
- Universal Running Gear
- MIGRunner™ Cart 195445
- Running Gear Cylinder Rack 300408
- Coolmate™ Coolant System
- Industrial MIG 4/0 Kits 300405 (Dinse) 300390 (Lugs)
- Gas Valve Kit 195286 XMT 350/425 300928 XMT 450

\*Optional 115-volt auxiliary power provides 10 amps of circuit-breaker protected power for coolant systems, etc.  
\*\*Duty cycle rating below achieved with 6-gauge input power cord (8-gauge cord supplied with unit).

Model/Stock Number	Input Power	Amperage/ Voltage Ranges	Rated Output	Amps Input at Rated Load Output							Max. Open-Circuit Voltage	Dimensions	Net Weight
				208 V	230 V	400 V	460 V	575 V	KVA	KW			
<b>XMT 350 CC/CV</b> (Dinse) <b>(907161)</b> 208-575 V, 50/60 Hz <b>(907161011)</b> 208-575 V, w/auxiliary power*, 50/60 Hz <b>(907161012)</b> Auto-Line w/auxiliary power, 50/60 Hz, <b>CE</b> <b>XMT 350 MPa</b> (Dinse except where noted) <b>(907366)</b> 208-575 V, 50/60 Hz <b>(907366011)</b> 208-575 V, w/auxiliary power*, 50/60 Hz <b>(907366014)</b> 208-575 V, with Tweco®, 50/60 Hz <b>(907366002)</b> w/auxiliary power, 50/60 Hz, <b>CE</b>	3-phase	5-425 A 10-38 V	350 A at 34 VDC, 60% duty cycle	40.4	36.1	20.6	17.8	14.1	14.2	13.6	75 VDC	H: 432 mm (17 in.) W: 318 mm (12.5 in.) D: 610 mm (24 in.)	36.3 kg (80 lb.) 43 kg (94.8 lb.) w/aux power
	1-phase	5-425 A 10-38 V	300 A at 32 VDC, 60% duty cycle	60.8	54.6	29.7	24.5	19.9	11.7	11.2			
<b>XMT 425 CC/CV</b> <b>(907386)</b> 230-575 V, 50/60 Hz	3-phase		425 A at 27 VDC, 30% duty cycle	–	36.1	20.6	17.8	14.1	14.2	13.6	90 VDC	H: 438 mm (17.25 in.) W: 368 mm (14.5 in.) D: 689 mm (27.125 in.)	55.3 kg (122 lb.)
<b>XMT 450 CC/CV</b> <b>(907481)</b> 230/460 V, 60 Hz <b>(907525)</b> 400 V w/auxiliary power*, 50/60 Hz, <b>CE</b> <b>XMT 450 MPa</b> <b>(907479)</b> 230/460 V, 60 Hz <b>(907468)</b> 400 V, w/auxiliary power, 50/60 Hz, <b>CE</b>	3-phase	15-600 A 10-38 V	450 A at 38 VDC, 100% duty cycle	–	51	–	27.6	24.4	22	18.9			
				–	51	–	27.6	23.6	21.6	18.3 (KVA is 23.5 on 575 V)			





## XMT<sup>®</sup> 350 FieldPro<sup>™</sup> Systems See literature DC/18.96



Top row left to right: ArcReach SuitCase 12 feeder, XMT 350 FieldPro power source, XMT 350 FieldPro with Polarity Reversing power source, and ArcReach Smart Feeder. Bottom row left to right: ArcReach Stick/TIG Remote and ArcReach Stick/TIG Remote with Polarity Reversing.

### ArcReach<sup>®</sup>

Every year, outdated welding equipment wastes hundreds of productive work hours – and thousands of dollars in profit – by forcing operators to make numerous walks from the weld joint to the welder. Welding systems with ArcReach technology let operators adjust welding parameters right at the weld joint without a control cord using the wire feeder or remote – maximizing arc-on time, improving safety and impacting the bottom line. Learn more about ArcReach technology at [MillerWelds.com/arcreach](http://MillerWelds.com/arcreach)

#### More jobsite productivity and efficiency

**Cable Length Compensation (CLC<sup>™</sup>)** ensures that the voltage a weld operator sets is the voltage they get by automatically adjusting voltage based on weld cable length, even hundreds of feet away from the power source.

**Polarity reversing models of power source and remote** are ideal for pipe and module assembly where changing polarity happens frequently.

**AUTO-LINE<sup>™</sup> TECHNOLOGY** For portability and reliability, Auto-Line allows for any input voltage hookup (208–575 V, single- or three-phase) with no manual linking, providing convenience in any job setting. Ideal solution for dirty or unreliable power.

**Auto-Bind<sup>™</sup>** automatically establishes exclusive communication between the power source and the wire feeder, using the existing weld cables upon system power up.

#### Exceptional arc performance

**Common weld failures can be minimized** with stick stops that are specifically programmed to eliminate arc strikes outside of the heat-affected zone.

**Regulated Metal Deposition (RMD<sup>®</sup>) and pulsed MIG** are fully supported, enabling operators to use these advanced processes in the field for faster, more-efficient welds (with ArcReach Smart Feeder).

#### Increased uptime

**Delivers the performance you need.** XMT 350 FieldPro welders and ArcReach feeders and remotes have been extensively proven in the field.

**Wind Tunnel Technology<sup>™</sup>**: Internal air flow that protects electrical components and PC boards from dirt, dust, debris... greatly improving reliability.

**Eliminate expenses related to maintaining or replacing easily damaged control cords** because the weld cables are used to communicate weld parameters between the wire feeder and power source.

#### Improved jobsite safety

**ArcReach<sup>®</sup> technology decreases the chances of slip, trip or fall injuries** by allowing weld operators to make parameter changes at the wire feeder or remote instead of having to travel through multistory and cluttered jobsites back to the power source.

#### Maximum fleet compatibility

**Maximize fleet compatibility** and get the benefits of ArcReach when you pair XMT 350 FieldPro welders and ArcReach feeders with other ArcReach compatible products.

#### More operator control

**Adjust While Welding (AWW<sup>™</sup>)** allows weld operators to change weld parameters while the arc is on.

**Inadvertent parameter changes by other jobsite workers can be easily avoided** because connecting an ArcReach accessory from the power source automatically locks out the power source's panel controls.

**Return to a previous weld process faster** because the power source is restored to its previous settings once the ArcReach accessory is removed.

**Auto-Process Select<sup>™</sup> decreases the chance of an incorrect weld process being used** because it automatically sets the power source to the correct weld process based on the polarity applied to the weld accessory.

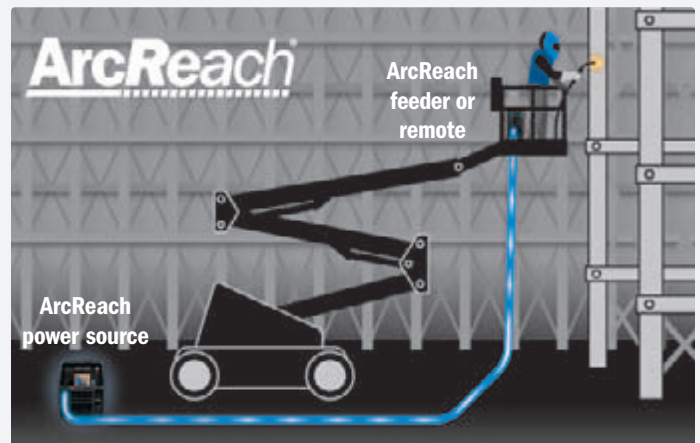



## XMT® 450 CC/CV ArcReach® See literature DC/18.94



Note: XMT 450 CC/CV ArcReach does not support the Cable Length Compensation (CLC™) and Adjust While Welding (AWW™) features or the ArcReach Smart Feeder.

**Auto-Process Select.™** System automatically changes to MIG/FCAW (with gas) if electrode positive polarity is detected or FCAW (no gas) if electrode negative polarity is detected, when ArcReach communication is established between the feeder and the XMT – reducing the need to access the power supply.

**Automatic return to panel settings.** System automatically returns to XMT setting when ArcReach communication is terminated. For example, if the XMT is set to gouging at 550 amps and an ArcReach feeder is connected, the XMT will go to a MIG/FCAW process. If the feeder is disconnected, the XMT will go back to its previous setting (gouging at 550 amps).

**Auto-Bind™** automatically establishes exclusive communication between the power source and the wire feeder, using the existing weld cables upon system power up.

**Operator can precisely set arc voltage at the feeder** and monitor the actual arc voltage and current delivered to the weld using the digital meters on the feeder. This removes guesswork when it comes to adhering to weld procedures.

**Remote override of XMT.** When an ArcReach feeder is connected to an XMT 450 ArcReach the feeder has full control and the XMT controls are disabled, preventing accidental changes by personnel other than the welding operator.

**Heavy industrial** ●  
**CC/CV DC 3 1** XMT 450  
 Phase Phase is 3-phase only.

### Processes

- MIG (GMAW) ▪ Stick (SMAW)
  - TIG (GTAW) ▪ Flux-cored (FCAW)
  - RMD\* ▪ Pulsed MIG (GMAW-P)\*
  - Air carbon arc cutting and gouging (CAC-A) (carbons – 304: 6.4 mm [1/4 in.], 350: 6.4 mm [1/4 in.], 450: 7.9 mm [5/16 in.]
- \*XMT 350 FieldPro only with ArcReach Smart Feeder.

### Stick/TIG

- XMT 350 FieldPro power source
- ArcReach Stick/TIG Remote

### MIG/flux-cored

- XMT 350 FieldPro power source
- ArcReach SuitCase 12 feeder and Bernard® BTB Gun 300 A

### RMD/pulse

- XMT 350 FieldPro power source
- ArcReach Smart Feeder and Bernard® PipeWox 300-15 MIG gun

### Most popular accessories

- XR-AlumaFeed® SuitCase® 301567
- SuitCase® Feeders
- ArcReach® Smart Feeder (for XMT 350 FieldPro power sources only)
- 20 and 70 Series Feeders
- Spoolmatic®/WC-24
- XR™S Control
- ArcReach® Stick/TIG Remote 301325 (Tweco®)
- ArcReach® Stick/TIG Remote with Polarity Reversing 300934 (Tweco®), 301176 (Dinse) (for XMT 350 FieldPro with Polarity Reversing power source only)
- Dinse 70 Series 134460 Male, 136600 Female

### ArcReach® Heater

(for XMT 350 FieldPro power sources only)



## XMT Racks

All the benefits of an individual XMT in an easy-to-transport package for multiple arcs in the field.



XMT 350 FieldPro Rack shown.

**Flexible solution.** The flexibility of the XMT makes it ideal for multiple system racks. Every system in a rack can be used for different tasks on-site, increasing fleet utilization and making the best use of equipment budgets.

**Easy installation.** The power distribution system on the rack allows the entire rack to be wired into a single power drop, isolating high-voltage power in the field.

Model	Stock Number	Input Power to Rack
XMT 350 FieldPro	4-Pack Rack (907739) 6-Pack Rack (907740)	230-575 V, three-phase. (Fused for 460/575 V)
XMT 350 FieldPro Polarity Reversing	4-Pack Rack (907742) 6-Pack Rack (907741)	230-575 V, three-phase. (Fused for 460/575 V)
XMT 450 CC/CV ArcReach	4-Pack Rack (907700)	230/460 V, three-phase. (Fused for 460 V)
Empty Rack	(300970)	

\*Optional 115-volt auxiliary power provides 10 amps of circuit-breaker protected power for coolant systems, etc.

\*\*Duty cycle rating below achieved with 6-gauge input power cord (8-gauge cord supplied with unit).

	Model/Stock Number	Input Power	Amperage/Voltage Ranges	IP Rating	Rated Output	Amps Input at Rated Load Output, 60 Hz							Max. Open-Circuit Voltage	Dimensions	Net Weight
						208 V	230 V	400 V	460 V	575 V	KVA	KW			
350 A	XMT 350 FieldPro Power Source only (907730) 208-575 V with Tweco® (907730002) 208-575 V with Dinse (907730001) 208-400 V with Dinse, CE	3-phase	5-425 A 10-38 V	IP23	350 A at 34 VDC, 60% duty cycle	40.4	36.1	20.6	17.8	14.1	14.2	13.6	75 VDC	H: 432 mm (17 in.) W: 318 mm (12.5 in.) D: 610 mm (24 in.)	42.2 kg (93 lb.)
		1-phase	5-425 A 10-38 V		300 A at 32 VDC, 60% duty cycle**	60.8	54.6	29.7	24.5	19.9	11.7	11.2			
	XMT 350 FieldPro with Polarity Reversing Power Source only (907731) 208-575 V with Tweco® (907731002) 208-575 V with Dinse (907731001) 208-400 V with Dinse, CE	3-phase	5-425 A 10-38 V	IP23	350 A at 34 VDC, 60% duty cycle	40.4	36.1	20.6	17.8	14.1	14.2	13.6	75 VDC	H: 432 mm (17 in.) W: 318 mm (12.5 in.) D: 610 mm (24 in.)	42.2 kg (93 lb.)
		1-phase	5-425 A 10-38 V		300 A at 32 VDC, 60% duty cycle**	60.8	54.6	29.7	24.5	19.9	11.7	11.2			
450 A	XMT 450 CC/CV ArcReach (1/2 in. stud) (907481003) 230/460 V (907481004) 230/460 V w/auxiliary power*	3-phase	15-600 A 10-38 V	IP23	450 A at 38 VDC, 100% duty cycle	–	51	–	27.6	24.4	22	18.9	90 VDC	H: 438 mm (17.25 in.) W: 368 mm (14.5 in.) D: 689 mm (27.125 in.)	55.3 kg (122 lb.)

Wire Feeder Model/Stock Number	Input Power	Input Welding Circuit Rating	Wire Feed Speed	Wire Diameter Type and Capacity	Maximum Spool Size Capacity	Dimensions	Net Weight
ArcReach Suitcase 8 (301457) Tweco®, CE	Operates on open-circuit voltage and arc voltage: 14-48 VDC/110 max. OCV	330 A at 60% duty cycle	1.3-19.8 mpm (50-780 ipm) dependent on arc voltage	<b>Solid wire</b> 0.6-1.4 mm (.023-.052 in.) <b>Flux-cored</b> 0.8-2.0 mm (.030-5/64 in.)	203 mm (8 in.), 6.4 kg (14 lb.)	H: 324 mm (12.75 in.) W: 184 mm (7.25 in.) D: 457 mm (18 in.)	13 kg (28 lb.)
ArcReach Suitcase 12 (301456) Tweco®, CE	Operates on open-circuit voltage and arc voltage: 14-48 VDC/110 max. OCV	425 A at 60% duty cycle	1.3-19.8 mpm (50-780 ipm) dependent on arc voltage	<b>Solid wire</b> 0.6-1.4 mm (.023-.052 in.) <b>Flux-cored</b> 0.8-2.0 mm (.030-5/64 in.)	305 mm (12 in.), 20 kg (45 lb.)	H: 394 mm (15.5 in.) W: 229 mm (9 in.) D: 533 mm (21 in.)	15.9 kg (35 lb.)
FieldPro Smart Feeder (301177) Dinse, CE (300935) Tweco® (300935002) Tweco® w/flowmeter	Operates on open-circuit voltage and arc voltage: 14-48 VDC/110 max. OCV*	275 A at 60% duty cycle	1.3-12.7 mpm (50-500 ipm) dependent on arc voltage	0.9-1.1 mm (.035-.045 in.)	305 mm (12 in.), 15 kg (33 lb.)	H: 457 mm (18 in.) W: 330 mm (13 in.) D: 546 mm (21.5 in.)	23 kg (50 lb.)



# MULTIPROCESS

## XMT® 650 Series See literature DC/18.98

Developed for harsh environmental conditions and output requirements that range from power-intensive to precise.



XMT 650 ArcReach power source (top center) shown with ArcReach 16 feeder (top left, field roller option shown), ArcReach SuitCase 12 Heavy Duty feeder (top right), and ArcReach Stick/TIG Remote (left). All sold separately.

### ArcReach®

Every year, outdated welding equipment wastes hundreds of productive work hours – and thousands of dollars in profit – by forcing operators to make numerous walks from the weld joint to the welder. Welding systems with ArcReach technology let operators adjust welding parameters right at the weld joint without a control cord using the wire feeder or remote – maximizing arc-on time, improving safety and impacting the bottom line. Learn more about ArcReach technology at [MillerWelds.com/arcreach](http://MillerWelds.com/arcreach)

Note: ArcReach Smart Feeder is not supported.

**Three models available: with or without ArcReach, and ArcReach with polarity reversing.** ArcReach models allow control of ArcReach accessories hundreds of feet away without a control cable. Polarity reversing model adds switching between FCAW EN and gouging without swapping cables.



**LED process indicator (ArcReach model without polarity reversing shown).** Process selections are illuminated with an LED that identifies process. Enables weld process to be seen from a distance.

**Cable Length Compensation (CLC™)** ensures that the voltage a weld operator sets is the voltage they get by automatically adjusting voltage based on weld cable length, even hundreds of feet away from the power source.

**Adjust While Welding (AWW™)** allows weld operators to change weld parameters while the arc is on.

**All aluminum construction** helps the machine resist corrosion for long life.

**Exclusive protection input inductor** protects machine's performance and reliability from "dirty" input power.

**Wind Tunnel Technology™** Internal air flow that protects components, greatly improving reliability.

**Fan-On-Demand™** cooling system only operates when needed, reducing power consumption and keeping internal components cleaner.

**High-quality performance** in all welding processes, from thick to thin metals.

**Infinite arc control** available in the Stick and Wire modes for easier fine tuning of tough-to-weld materials and out-of-position applications.

**Reduced size and weight** results in an easier-to-handle package that exceeds the welding performance of larger, heavier machines.

**High electrical efficiency and excellent power factor** mean getting more welding done while using less power.

**Return to a previous weld process faster** because the power source is restored to its previous settings once the ArcReach accessory is removed.

**Polarity reversing model** allows welding operator to change process and polarity with an ArcReach® 16 wire feeder. Stay at the weld joint and switch between welding and gouging with the push of a button.

Heavy industrial

### Processes

- MIG (GMAW) ▪ Flux-cored (FCAW)
- Stick (SMAW) ▪ TIG (GTAW)\*
- Submerged arc (SAW)\*
- Air carbon arc cutting and gouging (CAC-A) (rated 9.5 mm [3/8 in.] carbons)

\*XMT 650 models without polarity reversing.

### Most popular accessories

- **XMT 650 ArcReach® 4-Pack Racks**
  - 907860 Without polarity reversing
  - 907852 With polarity reversing
  - 293380 Empty rack fused for 460 V
- Occupied racks come assembled with four XMT 650 ArcReach power sources fused for 460 volts
- ArcReach® 16 Feeder
- ArcReach® SuitCase® Feeders
- ArcReach® Stick/TIG Remote 301325 (for ArcReach models only)
- ArcReach® Heater (for ArcReach models only)
- Running Gear Cylinder Rack 300408
- Industrial MIG 4/0 Kit (with lug connectors) 300390
- Extension Cables
  - 242208025 7.6 m (25 ft.)
  - 242208050 15 m (50 ft.)
  - 242208080 24.4 m (80 ft.)

\*Not available with polarity reversing models. \*\*Values in parentheses are for 575 V.

Model/Stock Number	Amperage/ Voltage Ranges	Rated Output	Amps Input at Rated Output, 50/60 Hz					Max. Open-Circuit Voltage	Power Source Dimensions (Includes lift eye)	Power Source Net Weight
			380 V	460 V	575 V	KVA**	KW**			
XMT 650 CC/CV 907843 380/460 V power source only	CC mode: 10–815 A CV mode: 10–44 V SAW mode: 10–65 V*	650 A at 44 VDC, 100% duty cycle	51.5	42.6	35.2	33.9 (35.3)	31.9 (31.7)	82 VDC	H: 716 mm (28.187 in.) W: 424 mm (16.687 in.) D: 803 mm (31.625 in.)	72.1 kg (159 lb.)
XMT 650 ArcReach 907823 380/460 V power source only		750 A at 44 VDC, 60% duty cycle	59.9	49.1	41.1	39.1 (41.0)	37.2 (37.4)			
XMT 650 ArcReach w/Polarity Reversing 907822 380/460 V power source only		815 A at 44 VDC, 25% duty cycle	65.3	53.6	44.3	42.7 (44.2)	40.5			





## PipeWorx 400 Welding System

See literature PWS/2.0

Designed exclusively for pipe fabrication shops.



### Simple process setup

- Setting up a new weld process is simple, requiring fewer steps, less training, and minimizing potential errors
- The front panel was designed by welders for welders – only backlit controls are adjustable to eliminate confusion
- The memory feature stores four programs for stick, DC TIG, and wire processes (left and right feeder side) each

### Streamlined system

- Innovative cable and gun storage maintains an organized weld-cell area – cables stay connected to the power source, eliminating the need for switching when changing welding processes
- All system components are tailored to meet the demands of a pipe fabrication shop

### Multiprocess machine

- Includes conventional stick, DC TIG (Lift-Arc™ or HF start), flux-cored and MIG welding processes
- Features advanced RMD and pulsed MIG processes for high-quality welds, enhanced productivity, and less rework and training

### Quick process changeover

- PipeWorx “Quick-Select” technology auto-chooses welding process, polarity, cable outputs, and parameters
- Eliminates set-up time for switching cables and gas hoses

Heavy industrial ● CC CV DC 3 Phase

### Processes

- Stick (SMAW) ▪ DC TIG (GTAW)
- MIG (GMAW) ▪ Flux-cored (FCAW)
- RMD ▪ Pulsed MIG (GMAW-P)

### PipeWorx welding system (sold separately)

- PipeWorx 400 power source with cable hangers (907534)
- Dual-wire feeder with drive rolls (300949)
- Two Bernard® PipeWorx 300-15 MIG guns (195400)
- Running gear with gas cylinder rack and handles (300368)
- PipeWorx accessories kit for dual-wire feeder (300568) consisting of 7.6 m (25 ft.) work cable with EG500 clamp, two flowmeter regulators and two 1.5 m (5 ft.) gas hoses
- Cable kit with 7.6 m (25 ft.) work sense lead (300367)

### Most popular accessories

- Bernard® PipeWorx 300-15 Gun 195400 4.6 m (15 ft.)
- Composite Cable Kit 300454 7.6 m (25 ft.) 300456 15.2 m (50 ft.)



- PipeWorx Cooler 300370
- Coolant 043810
- Foot Control Bracket 300676
- RFCS-14 HD 301589
- RPBS-14 300666
- Wireless Remote Foot Control 301580
- TIG torch (WP1825RM) with adapter (45V11)

## Advanced Technologies of PipeWorx System

### Regulated Metal Deposition (RMD®)

- Higher quality root pass
- Calm and stable arc
- Less spatter
- Less chance of cold lap or lack of fusion; reduces rework
- More tolerant of hi-lo conditions
- Reduced training requirements
- Can eliminate the need for a hot pass
- Can eliminate backing/purge gas in some stainless applications



RMD carbon steel

### Pulsed MIG

- Less heat input than traditional spray pulse transfer
- Shorter arc length
- Narrower arc cone
- Improved fusion and fill at the toes of the weld resulting in:
  - Faster travel speeds
  - Higher deposition rates
- Less training time required because pulsed MIG:
  - Virtually eliminates arc wander
  - Is easier to control the puddle
  - Compensates for tip-to-work variations automatically
- When used with RMD, it is possible to use one wire and one gas for all passes



Pulsed MIG stainless

\*Dimensions and weight are for power source only.

Model/Stock Number Most Popular System	Welding Mode/ Process	Amperage/ Voltage Ranges	Rated Output at 100% Duty Cycle	Amps Input at Rated Output, 60 Hz, 3-Phase			KVA			KW			Max. Open- Circuit Voltage	Dimensions*	Net Weight*
				230 V	460 V	575 V	230 V	460 V	575 V	230 V	460 V	575 V			
PipeWorx 400 Welding System PipeWorx 400 Power Source only 907382 230/460 V 907384 575 V	CC: Stick	40-400 A	400 A at 36 VDC	43.9	26.6	22.4	17.5	21.2	22.3	16.1	16.3	16.4	90 VDC H: 724 mm (28.5 in.) W: 495 mm (19.5 in.) D: 806 mm (31.75 in.)	102 kg (225 lb.)	
	CC/DC: TIG	10-350 A	350 A at 24 VDC	29.3	18.2	13.5	11.8	14.5	13.4	10.7	10.6	10			
	CV: MIG/flux-cored	10-44 V	400 A at 34 VDC	42.9	24	20.5	17.3	19.2	20.5	16	15.8	16.2			
Model/Stock Number	Input Power	Input Welding Circuit Rating	Wire Feed Speed	Wire Diameter Capacity		Maximum Spool Size Capacity	Dimensions		Net Weight						
PipeWorx Dual Feeder 300366 300950, CE	24 VAC, 11 A	100 V, 750 A at 100% duty cycle	1.3-19.8 m/min. (50-780 ipm)	0.9-1.6 mm (.035-.062 in.)		27 kg (60 lb.)	H: 356 mm (14 in.) W: 483 mm (19 in.) D: 737 mm (29 in.)		41 kg (90 lb.)						

# NEWSLETTERS DELIVERED RIGHT TO YOUR INBOX



**DIY** – Project ideas, how-to videos, tips and more for welding do-it-yourselfers.

**PRO** – Industry news, technical information and application videos for welding professionals.



**THE BEVEL** – Success stories, resources and events for pipe, construction and fabrication professionals.

**INSTRUCTOR** – Classroom resources, safety tips and school spotlights for welding instructors.



**SAFETY** – Regulatory updates, industry news and solutions for occupational health and safety professionals.

**alumaNATION** – Tips, projects and technical information for anyone who welds aluminum.



**WORK TRUCK TODAY** – Resources, best practices and industry trends for work truck fleet operators and managers.

Sign up now at  
[MillerWelds.com/newsletters](https://MillerWelds.com/newsletters)

## Follow us @MillerWelds

NEW!



Find videos to help you improve your skills and inspire your next project.

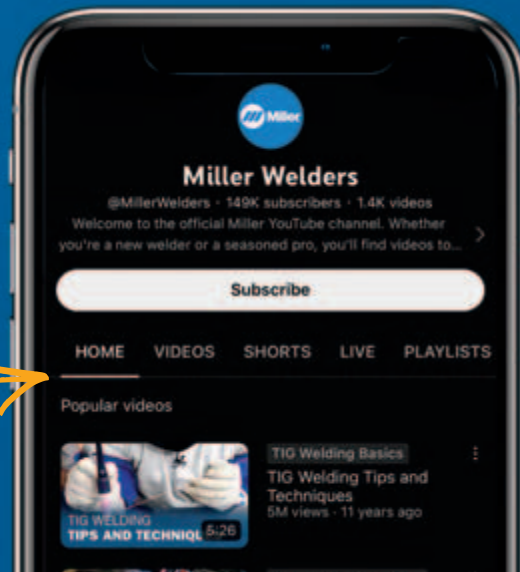



# Miller recommends



ITW Orbital Cutting & Welding

**Applications, e.g.**

pharmaceutical, biotechnology & chemical industry

« orbital (TIG) welding power sources and orbital welding heads »

food & beverage industry

semiconductor industry

pipe cutting & beveling machines

aerospace industry

tube facing machines

heating, ventilation & air conditioning industry

pipe end prep machines

power generation industry

The ITW ORBITAL CUTTING & WELDING division with its brands ORBITALUM TOOLS and E.H. WACHS provides global customers one source for the finest in pipe & tube cutting, beveling and orbital welding products.

**WORLDWIDE SALES & SERVICE:**



EUROPE, ASIA, AFRICA & MIDDLE EAST:  
**Orbitalum Tools GmbH**  
 Josef-Schuetzler-Str. 17  
 78224 Singen, Germany  
 Tel. +49 (0) 77 31-792 0  
 tools@orbitalum.com  
 www.orbitalum.com



NORTH AMERICA:  
**E.H. Wachs**  
 600 Knightsbridge Parkway  
 Lincolnshire, IL 60069, USA  
 Tel. +1 847 537 8800  
 Toll Free 800 323 8185  
 sales@ehwachs.com  
 www.ehwachs.com





# SMAW STICK



For more detailed information, visit

MillerWelds.com/stick

Also see Multiprocess and TIG sections for machines that can stick weld.

## Product Guide

	Class	Stick	DC TIG	Portability	Weldable Metals	Welding Amperage Range	Special Features	Typical Applications
1-Ph	Thunderbolt® 210	●	●	Handle, shoulder strap	Steel, stainless	20-210 DC	Infinite amperage control	Garage/job shops, maintenance/repair, farm
	Maxstar® 161 S	●	●	Handle/shoulder strap, optional case		20-160 DC	Auto-Line™ (120-240 V), digital meter	MRO, ship installation/repair, farm/ranch
1- & 3-Ph	Maxstar® 210 STR	●	●	Handles, shoulder strap, optional cart	Steel, stainless	10-210 DC	Auto-Line™ (120-480 V), digital meters	Construction, fabrication, pipe, steel erection, shipbuilding
	CST™ 282	●	●	Handle, optional cart		5-280 DC	Portable at 34.6 lb., Auto-Line™ (208-575 V), digital meter, also available in multioperator rack	Construction, fabrication, pipe, steel erection, shipbuilding
3-Ph	CST™ 282 Rack	●	●	Lift eye, casters	Steel, stainless	5-280 DC	Up to 4 or 8 operators, light weight	Construction, maintenance/repair, shipbuilding

### Product Key

Class: ● Light industrial ● Industrial ● Heavy industrial Capability: ● Designed for this process ● Capable of this process

## Thunderbolt® 210

See literature DC/37.0

Dependable, portable, powerful stick welder.



**Portable with adjustable handle/shoulder strap.** Easy to transport at only 7 kg (15.5 lb.).

**More powerful.** Up to 85 more amps compared to leading competitive machine means you can weld thicker materials.

**Hot Start™** technology provides easy, quick and reliable arc starts.

**Precise, accurate, infinite amperage control and heat output.**

Light industrial ● CC DC 1 Phase

Process - Stick (SMAW)

Comes complete with

- 3 m (10 ft.) No. 4 electrode cable with heavy-duty electrode holder
- 3 m (10 ft.) work cable with clamp
- 2 m (6.5 ft.) power cord 240 V plug
- Cable pouch

Stock Number	Input Power	Welding Amperage Range	Rated Output	Amps Input at Rated Output, 50/60 Hz	Max. Open-Circuit Voltage	Dimensions	Net Weight
907722	240 V	25-210	210 A at 20% duty cycle	43.4	85 VDC	H: 267 mm (10.5 in.) W: 181 mm (7.125 in.) D: 340 mm (13.375 in.)	7.0 kg (15.5 lb.)

## Maxstar® 161 S

See literature DC/27.3

Industrial class – provides maximum portability and performance in the most compact stick package in the industry.



Maxstar 161 S with X-CASE shown.



Allows for any input voltage hookup (120-240 V) with no manual linking, providing convenience in any job setting. Ideal solution for dirty or unreliable power.

**Portable with adjustable handle/shoulder strap.** Easy to transport at only 5.9 kg (13 lb.).

**Fan-On-Demand™** power source cooling system operates only when needed, reducing noise, energy use and the amount of contaminants pulled through the machine.

**Digital meter** for more precise control when presetting or monitoring welding amperage.

**Adaptive Hot Start™** for stick arc starts.

**Stick-Stuck** detects if the electrode is stuck to the part and turns the welding output off to safely and easily remove the electrode. Menu selectable.

**Superior stick arc performance** even on the difficult-to-run electrodes like E6010.

Industrial ● CC DC 1 Phase

Process - Stick (SMAW)

Comes complete with

- 2 m (6.5 ft.) power cords for 120 V and 240 V
- 4 m (13 ft.) electrode cable with holder and 25 mm Dinse-style connector
- 3 m (10 ft.) work cable with clamp and 25 mm Dinse-style connector
- Quick-reference guide

**907709001 includes above plus**

- Protective X-CASE™

**Most popular accessories**

- Protective X-CASE™ 301429

Stock Number	Input Power	Welding Amperage Range	Rated Output	Amps Input at Rated Output, 50/60 Hz	KVA at Duty Cycle	KW	Max. Open-Circuit Voltage	Dimensions	Net Weight
907709	120 V	20-90	90 A at 23.6 V, 30% duty cycle	23.2	2.8	2.8	48 VDC (12-16 VDC*)	H: 262 mm (10.3 in.) W: 142 mm (5.6 in.) D: 343 mm (13.5 in.)	5.9 kg (13 lb.)
907709001 With X-CASE		20-160	160 A at 26.4 V, 20% duty cycle	22.6	5.4	5.3			

See the TIG section for Maxstar 161 STL and STH



Industrial ● **CC DC** **3 1**  
Phase Phase

# Maxstar® 210 STR See literature DC/32.1

Maximum flexibility with automatic connection to any input power while maintaining the best DC stick/TIG welding performance in its product class.



**AUTO-LINE** TECHNOLOGY Allows for any input voltage hookup (120–480 V) with no manual linking, providing convenience in any job setting. Ideal solution for dirty or unreliable power.

**Lift-Arc™** provides DC TIG arc initiation without the use of high frequency.

**Dual schedule** allows operators to switch between welding parameters for specific electrodes without readjusting the machine.

**Hot Start™** adaptive control provides positive arc starts without sticking.

**Stick-Stuck** detects if the electrode is stuck to the part and turns the welding output off to safely and easily remove the electrode. Menu selectable.

**Fan-On-Demand™** power source cooling system operates only when needed, reducing noise, energy use and the amount of contaminants pulled through the machine.

**Remote amperage control.**

**Digital meters** for more precise control when presetting or monitoring welding amperage.

**Portable with adjustable shoulder strap.**

**Processes**

- Stick (SMAW) • TIG (GTAW)

**Comes complete with**

- 2.4 m (8 ft.) power cord (no plug)
- Two 50 mm Dinse-style connectors

**Most popular accessories**

- 3.8 m (12.5 ft.) Weldcraft™ A-150 Valve TIG torch WP-17V-25-2
- Remote Controls
- Air-Cooled TIG Torch Connector

\*Sense voltage for stick and Lift-Arc TIG.

Stock Number 907682	Welding Process	Input Power	Welding Amperage Range	Rated Output at 60% Duty Cycle	Amps Input at Rated Load Output, 50/60 Hz						Max. Open-Circuit Voltage	Dimensions	Net Weight	
					120 V	208 V	240 V	400 V	480 V	KVA				KW
Stick		3-phase	10-210	160 A at 26.4 V	–	15	13	8	6	5.5	5.2	80 VDC (11 VDC*)	H: 346 mm (13.6 in.) W: 219 mm (8.6 in.) D: 495 mm (19.5 in.)	16.3 kg (36 lb.)
		1-phase	10-210	160 A at 26.4 V	–	26	22	13	11	5.3	5.3			
		1-phase (120 V)	10-100	90 A at 23.6 V	23	–	–	–	–	2.8	2.8			
TIG		3-phase	10-210	210 A at 18.4 V	–	14	12	7	6	5.2	4.9			
		1-phase	10-210	210 A at 18.4 V	–	24	20	12	10	4.9	4.9			
		1-phase (120 V)	10-150	125 A at 15 V	22	–	–	–	–	2.6	2.6			



Miller recommends



Filler metals are a critical component in any weld project. They become part of your end product and choosing the right filler metal can affect the look and quality of your weld.

To make your filler metal choice easier, **Hobart offers a FREE app for download** on both Android™ and Apple® devices. Features of the app include:

- Recommendations for aluminum, carbon steel and stainless steel welding
- Calculates the amount of filler metal needed for your job
- Heat input calculator
- Hardfacing cross-reference function

**Download the Filler Metal Selector and Calculator app today.**



## CST™ 282

See literature DC/29.6

**Durable power source designed for the construction industry. Ideal for stick electrodes up to 4.8 mm (3/16 in.) and TIG welding of pipe and plate.**



CST 282 with Tweco®-style receptacles shown.

**Superior stick arc performance** even on the difficult-to-run electrodes like E6010.

**AUTO-LINE TECHNOLOGY** For portability and reliability, Auto-Line allows for any input voltage hookup (208–575 V, single- or three-phase) with no manual linking, providing convenience in any job setting. Ideal solution for dirty or unreliable power.

**Digital meter** for more precise control when presetting or monitoring welding amperage.

**Portable** in the shop or at the jobsite – at 15.7 kg (34.6 lb.) the CST 282 is easily moved from location to location.

**Lift-Arc™** provides TIG arc initiation without the use of high frequency.

**Universal connector system** allows the machine to be quickly configured to either Tweco®, Dinse- or Cam-Lok™-style receptacles. Extra receptacles and wrench are sold separately as Universal Connector Kits.



Industrial ● **CC DC 3 1**  
Phase Phase

### Processes

- Stick (SMAW) ▪ TIG (GTAW)

### Comes with

- 1.8 m (6 ft.) power cord

### Most popular accessories

- CST 282 Rack (see below)
- Remote Controls
- Universal Connector Kits
  - 301611 Tweco-style receptacles
  - 301595 Dinse-style receptacles
  - 301637 Cam-Lok-style receptacles
  - 042533 One male Dinse
- For TIG torches see literature DC/29.6

Stock Number (907770) Tweco® (907810) Dinse 208–575 V	Welding Process	Input Power	Welding Amperage Range	Rated Output	Amps Input at Rated Load Output, 50/60 Hz					KVA	KW	Max. Open-Circuit Voltage	Dimensions	Net Weight	
					208 V	230 V	400 V	460 V	575 V						
	Stick	Three-phase	30–280	280 A at 31.2 V, 35% duty cycle	29.63	26.65	15.71	13.92	12.08	12	10.2	103 VDC	H: 343 mm (13.5 in.) W: 203 mm (8 in.) D: 470 mm (18.5 in.)	15.7 kg (34.6 lb.)	
				200 A at 28 V, 100% duty cycle	18.86	17.09	10.6	9.37	8.02	8	6.4				
		Single-phase	30–280	200 A at 28 V, 50% duty cycle	33.7	30.65	17.61	16.18	14.51	8.3	6.6				
				150 A at 26 V, 100% duty cycle	23.07	20.59	12.97	11.8	11.15	6.4	4.5				
	TIG	Three-phase	5–280	280 A at 21.2 V, 35% duty cycle	20.77	18.85	11.54	10.22	8.95	8.9	7.1				9.5 VDC
				200 A at 18 V, 100% duty cycle	12.89	11.74	7.42	6.55	5.49	5.4	4.3				
	Single-phase	5–280	200 A at 18 V, 50% duty cycle	22.12	19.71	12.89	11.06	10.61	6.1	4.4					
			150 A at 16 V, 100% duty cycle	14.84	13.38	8.73	8.63	7.72	5.1	2.9					

## CST™ 282 Racks

See literature DC/29.6

**Rugged enclosure provides simple means for protecting and transporting multiple welding power sources for construction, power plant turn-arounds and shipbuilding applications.**



4-pack rack

8-pack rack



**One easy connection** allows up to eight inverters to be connected with one primary power drop.

**All controls including power switch are located on front of machine** for easy access.

**Top cover** protects machines from falling debris.

**Lift eye(s)** simplify crane or overhead lifting device transport.

**Lift truck fork pockets.**

**Common output ground connection** (for same polarity use only).

**Racks include casters** that can be bolted to the rack base. Two swivel casters and two non-swivel casters. Large 127 mm (5 in.) diameter wheels enable the rack to be moved over grating and driveway gravel.

Heavy industrial ● **CC DC 3**  
Phase

### Processes

- Stick (SMAW) ▪ TIG (GTAW)

### Comes with

- Cables to connect power sources to common work connection
- 127 mm (5 in.) casters

### Most popular accessories

- Remote Controls
- For TIG torches see literature DC/29.6





Model	Stock Number	Rack Capacity	Input Power to Rack	Amps Input at Rated Load Output, 50/60 Hz			KVA	KW	Dimensions (H x W x D) (Includes lift eye)	Net Weight
			230 V	460 V	575 V					
4-Pack Rack	(907811) Tweco®	4 units	208–575 V, three-phase, 50/60 Hz (fused for 460 V)	106.5	56	48.5	48	40.8	1,289 x 648 x 673 mm (50.75 x 25.5 x 26.5 in.)	150 kg (330 lb.)
8-Pack Rack	(907812) Tweco®	8 units		213	112	97	96	81.6	1,508 x 1,092 x 873 mm (59.38 x 43 x 34.38 in.)	250 kg (550 lb.)
Empty Rack	(301610)	8 units	–	–	–	–	–	Same as 8-pack rack above	127 kg (280 lb.)	



# Miller recommends



ITW Orbital Cutting & Welding

<p>Applications, e.g.</p>	<p>Portable weld prep machine tools for industrial applications, e.g.</p>
 <p>oil, gas &amp; petrochemical industry</p>	<p>NEW DynaPrep MDSF split frames for heavy duty form tooling &amp; pipe weld preparation</p>
 <p>power generation industry</p>	<p>HDSF heavy duty split frames - built for big jobs in the field</p>
 <p>pipeline distribution</p>	 <p>TRAV-L-CUTTER portable milling machines</p>
 <p>off-shore</p>	<p>LCSF low clearance split frames</p>
<p>SDB / FF small diameter bevelers &amp; flange facers</p>	<p>EP 424 ID mount end prep machines</p>

The ITW ORBITAL CUTTING & WELDING division with its brands E.H. WACHS and ORBITALUM TOOLS provides global customers one source for the finest in pipe & tube cutting, beveling and orbital welding products.

WORLDWIDE SALES & SERVICE:



NORTH AMERICA:

**E.H. Wachs**  
 600 Knightsbridge Parkway  
 Lincolnshire, IL 60069, USA  
 Tel. +1 847 537 8800  
 Toll Free 800 323 8185  
 sales@ehwachs.com  
 www.ehwachs.com



EUROPE, ASIA, AFRICA & MIDDLE EAST:

**Orbitalum Tools GmbH**  
 Josef-Schuetzler-Str. 17  
 78224 Singen, Germany  
 Tel. +49 (0) 77 31 - 792 0  
 tools@orbitalum.com  
 www.orbitalum.com



# TIG GTAW

For more detailed information, visit



[MillerWelds.com/tig](http://MillerWelds.com/tig)

Also see Multiprocess section for machines that can TIG weld.



## Product Guide

	Class	TIG	Pulsed TIG	Stick	CAC-A	MIG/Flux-cored	Max. Electrode Diameter					Material Thickness Range (TIG)	Welding Amperage Range	Pulse Capability	Net Weight	Generator Power Requirement	
							E6010/11	E6013	E7018	E7024	CAC-A						
DC (Steel)	Maxstar® 161	●	●	●	●		5/32 in.	1/8 in.	1/8 in.	3/32 in.	–	.020–3/16 in.	5–160 A	0–150 pps (STH model)	5.9 kg (13 lb.)	5.3 kW	
	Maxstar® 210	●	●	●	●		3/16 in.	3/16 in.	5/32 in.	5/32 in.	–	.002–1/4 in.	1–210 A	0.1–250 pps (base model) 0.1–500 pps (DX model)	17.2 kg (38 lb.)	9 kW	
	Maxstar® 280	●	●	●	●	●		7/32 in.	3/16 in.	3/16 in.	3/16 in.	3/16 in.	.004–3/8 in.	1–280 A	0.1–250 pps (base model) 0.1–500 pps (DX model)	21.3 kg (47 lb.)	11 kW
	Maxstar® 400	●	●	●	●	●		5/16 in.	5/16 in.	1/4 in.	1/4 in.	1/4 in.	.012–5/8 in.	3–400 A	0.1–5,000 pps	61 kg (134 lb.)	20 kW
AC/DC (Aluminum/Steel)	Diversion™ 180	●	●				–	–	–	–	–	.030–3/16 in. (alum.) .025–3/16 in. (steel)	10–180 A	–	23 kg (50 lb.)	5.5 kW	
	Syncrowave® 210	●	●	●	●	●	5/32 in.	1/8 in.	1/8 in.	3/32 in.	–	.020–1/4 in. (aluminum/steel)	5–210 A	0.1–150 pps	61 kg (133.5 lb.)	6 kW	
	Syncrowave® 300	●	●	●	●			5/32 in.	5/32 in.	1/8 in.	1/8 in.	–	.015–3/8 in. (alum.) .012–1/2 in. (steel)	5–300 A	0.1–150 pps	45.8 kg (101 lb.)	9 kW
	Syncrowave® 400	●	●	●	●			3/16 in.	3/16 in.	3/16 in.	3/16 in.	–	.015–1/2 in. (alum.) .012–5/8 in. (steel)	5–400 A	0.1–150 pps	59.4 kg (131 lb.)	14 kW
	Dynasty® 210	●	●	●	●			3/16 in.	3/16 in.	5/32 in.	5/32 in.	–	.012–1/4 in. (alum.) .002–1/4 in. (steel)	2–210 A (AC) 1–210 A (DC)	0.1–500 pps	21.3 kg (47 lb.)	9 kW
	Dynasty® 300	●	●	●	●	●		7/32 in.	3/16 in.	3/16 in.	3/16 in.	3/16 in.	.012–3/8 in. (alum.) .004–3/8 in. (steel)	2–300 A (AC) 1–300 A (DC)	0.1–500 pps	25 kg (55 lb.)	12.5 kW
	Dynasty® 400	●	●	●	●	●		5/16 in.	5/16 in.	1/4 in.	1/4 in.	1/4 in.	.015–5/8 in. (alum.) .012–5/8 in. (steel)	3–400 A	0.1–500 pps (AC) 0.1–5,000 pps (DC)	61 kg (134 lb.)	20 kW
	Dynasty® 800	●	●	●	●	●		5/16 in.	5/16 in.	5/16 in.	5/16 in.	3/8 in.	.020–1 in. (aluminum/steel)	5–800 A	0.1–500 pps (AC) 0.1–5,000 pps (DC)	90 kg (198 lb.)	50 kW

### Product Key

Class: ● Light industrial ● Industrial ● Heavy industrial Capability: ● All models ● Some models



# Diversion™ 180 AC/DC TIG

See literature AD/1.5

Professional-grade arc in a package designed specifically for personal users. Contains all of the features you need – simplicity combined with superior performance and value.



### TIG Welding Capability

Max. 4.8 mm (3/16 in.)	Max. 4.8 mm (3/16 in.)
Steel	Aluminum
Min. 0.6 mm (0.025 in.)	Min. 0.75 mm (0.030 in.)



**Multi-voltage plug (MVP™)** allows for connection to 120- or 240-volt receptacles without tools. Choose the plug that fits the receptacle and connect it to the power cord.

**Easy-to-understand operator interface.** Power up, select material type, set material thickness range and start welding!

**Inverter-based AC/DC power source** provides a more consistent welding arc while using less power.

**HF arc starting** for non-contact arc initiation that reduces tungsten and material contamination.

**Portable.** Easy to transport at 23 kg (50 lb.).

\*While idling.

**Fan-On-Demand™** power source cooling system operates only when needed, reducing noise, energy use and the amount of contaminants pulled through the machine.

**Auto-postflow** adjusts the length of postflow time based on the amperage setting, shielding your tungsten and eliminating the need to set the postflow time.

**Advanced squarewave AC** provides a fast freezing weld puddle and deeper penetration.

**Weldcraft™ A-150 torch with Diamond Grip™** provides more comfortable grip and reduces operator fatigue.

Light industrial ● CC AC/DC 1 Phase

Process - TIG (GTAW)

Comes with

- Power cord with MVP plugs for 120 V and 240 V
- 3.8 m (12.5 ft.) Weldcraft™ A-150 TIG torch
- 3.7 m (12 ft.) work cable with clamp
- RFCS-RJ45 remote foot control
- Flow gauge regulator with hose

Most popular accessories

- Running Gear/Cylinder Rack 301239
- Protective Cover 300579
- RCCS-RJ45 Remote Fingertip Control 301146
- RJ45 to 14-Pin Adapter Cord 300688
- Weldcraft™ Flexible Torch Body Kits (requires handle 105Z55R) A-125F (WP-9F) A-150F (WP-17F)
- TIG Torch Accessory Kit AK2C

AC/DC	Stock Number (907627)	Input Power	Welding Amp Range	Rated Output	Amps Input at Rated Output	KVA	KW	Max. Open-Circuit Voltage	Dimensions	Net Weight
			115 V	10-125	125 A at 15 V, 35% duty cycle	26.5 (.88*)	3.1 (.1*)	3.0 (.03*)	80 VDC	H: 433 mm (17 in.) W: 251 mm (9.875 in.) D: 608 mm (23.875 in.)
		230 V	10-180	150 A at 16 V, 20% duty cycle 180 A at 17.2 V, 10% duty cycle	16 (.44*) 20.5 (.44*)	3.7 (.1*) 4.7 (.1*)	3.6 (.03*) 4.6 (.03*)			

# Maxstar® 161 STL and STH DC TIG and Stick

See literature DC/27.5

Maximum portability and performance provided in one compact TIG/stick package.



### TIG Welding Capability

Max. 4.8 mm (3/16 in.)
Steel
Min. 0.5 mm (0.020 in.)

Two models available.

**STL:** DC TIG/stick with Lift-Arc™ starting without high frequency.  
**STH:** DC TIG/stick with high frequency and Lift-Arc™ starting, plus built-in pulsing from 0-150 pulses per second.

**AUTO-LINE TECHNOLOGY** Allows for any input voltage hook-up (120-240 V) with no manual linking.

**Portable with adjustable handle/shoulder strap.** Easy to transport at only 5.9 kg (13 lb.).

**Built-in gas solenoid** eliminates need for a bulky torch with a gas valve.

**Digital meter** for more precise control.

**Fan-On-Demand™** power source cooling system.

**Superior stick arc performance** even on the difficult-to-run electrodes like E6010.

Maxstar 161 STH TIG/stick package with remote fingertip control (907711001) shown – includes X-CASE.

\*Sense voltage for stick and Lift-Arc™ TIG.

Light industrial ● CC DC 1 Phase

Processes

- TIG (GTAW) ▪ Stick (SMAW)
- Pulsed TIG (GTAW-P) with STH model

Comes with

- 2 m (6.5 ft.) 120 V and 240 V power cords
- 4 m (13 ft.) electrode cable with holder and 25 mm Dinse-style connector
- 3 m (10 ft.) work cable with clamp and 25 mm Dinse-style connector
- Air-cooled TIG torch connector
- Quick-reference guide

TIG/stick packages include above plus

- 3.8 m (12.5 ft.) Weldcraft™ A-150 TIG torch (WP1712RDI25)
- Protective X-CASE™ (301429)
- Flow gauge regulator with hose
- AK2C TIG torch accessory kit
- RCCS-6M remote fingertip control (packages 907710002 and 907711001 only)

DC	Model/Stock Number	Model/Stock Number	Welding Process	Input Power	Welding Amp Range	Rated Output	Amps Input at Rated Output, 50/60 Hz	KVA at Duty Cycle	KW	Max. Open-Circuit Voltage	Dimensions	Net Weight
		<b>Maxstar 161 STL (907710)</b> Power source only <b>(907710001)</b> TIG/stick package <b>(907710002)</b> TIG/stick package with remote fingertip control	<b>Maxstar 161 STH (907711)</b> Power source only <b>(907711001)</b> TIG/stick package with remote fingertip control	TIG	120 V	5-130	130 A at 15.2 V, 30% duty cycle	22.6	2.73	2.70	48 VDC (12-16 VDC*)	H: 262 mm (10.3 in.) W: 142 mm (5.6 in.) D: 343 mm (13.5 in.)
				240 V	5-160	160 A at 16.4 V, 20% duty cycle	15.05	3.62	3.49			
			Stick	120 V	20-90	90 A at 23.6 V, 30% duty cycle	23.16	2.78	2.76			
				240 V	20-160	160 A at 26.4 V, 20% duty cycle	22.55	5.41	5.25			





## Syncrowave® 210 AC/DC TIG, Stick and MIG (with Spool Gun)

See literature AD/4.6

Continuing the tradition of innovation through advanced inverter technology for light-industrial users.



### Easy to use.

- 1) Turn power on.
- 2) Select the process.
- 3) Set amperage or voltage based on material thickness.

Then weld! It's easy as 1,2,3.

### TIG Welding Capability

Max. 6.4 mm (1/4 in.)

Steel	Aluminum
-------	----------

Min. 0.5 mm (0.020 in.)

**AUTO-LINE TECHNOLOGY** Allows for any input voltage hook-up (120-240 V) with no manual linking, providing convenience in any job setting. Ideal solution for dirty or unreliable power.



**Multi-voltage plug (MVP™)** allows for connection to 120- or 240-volt receptacles without tools. Choose the plug that fits the receptacle and connect it to the power cord.

**Low power draw.** Inverter-based power source provides full welding output from 240 volts while drawing less than 30 amps.

**High-frequency (HF) arc starting** for non-contact arc initiation, reducing tungsten and material contamination.

**Pro-Set™ (TIG/stick)** eliminates the guesswork when setting weld parameters. Use Pro-Set when you want the speed, convenience and confidence of preset controls.

**AC frequency (TIG)** controls the width of the arc cone and can improve directional control of the arc.

**AC balance (TIG)** control provides adjustable oxide removal which is essential for creating the highest quality aluminum welds.

**Pulse (TIG).** Pulsing can increase puddle agitation, arc stability and travel speeds while reducing heat input and distortion.

**DIG (stick)** control allows the arc characteristics to be changed for specific applications and electrodes. Lower the DIG setting for smooth running electrodes like E7018 and increase the DIG setting for stiffer, more penetrating electrodes like E6010.

**Auto-Set™ (MIG)** automatically sets your welder to the proper parameters. Simply set the wire size, material thickness, and shielding gas and you're ready to weld with the Spoolmate™ spool gun.

Light industrial ● CC AC 1 DC Phase

### Processes

- AC/DC TIG (GTAW) ▪ DC stick (SMAW)
- Pulsed TIG (GTAW-P) ▪ MIG (GMAW)\*
- Flux-cored (FCAW)\*

\*With Spoolmate 150.

### Comes with

- 3 m (10 ft.) power cord with MVP plugs for 120 V and 240 V
- 3.8 m (12.5 ft.) Weldcraft™ A-150 TIG torch (WP1712MFDI50)
- 3.7 m (12 ft.) work cable with clamp and Dinse-style connector
- Electrode holder with Dinse-style connector
- RFCS-14 HD foot control
- Flow gauge regulator with hose
- Factory-installed running gear with EZ-Change™ low cylinder rack
- Quick-reference guide

### Most popular accessories

- 7.6 m (25 ft.) Weldcraft™ A-150 TIG Torch WP-17-25-R

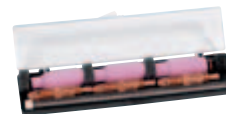

### ▪ TIG Torch Accessory Kit AK2C

Includes one short back cap, one of each size (#4, #5, #6) alumina nozzle, and one of each size (1, 1.6, 2.4 mm [.040, 1/16, 3/32 in.]) of the following: collet, collet body, and 178 mm (7 in.) 2% ceriated tungsten electrode

▪ TIG Torch Accessory Kit AK-150MFC  
Converts A-150 into 28 different torch styles while using existing cable – includes collets, collet bodies, nozzles, torch heads, handle and more

- Protective Cover 195142
- RCC-14 Remote Control 151086
- Wireless Remote Foot Control 301580

AC/DC	Stock Number 907596 TIG/stick only package	Input Power	Welding Process	Welding Amperage Range	Rated Output (R.M.S.) at 60% Duty Cycle	Amps Input at Rated Output	Max. Open-Circuit Voltage	Dimensions H: 800 mm (31.5 in.) W: 470 mm (18.5 in.) D: 1092 mm (43 in.)	Net Weight TIG/stick only: 61 kg (133.5 lb.) TIG/MIG Complete: 63 kg (139.5 lb.)
		115 V	DC TIG	5-125	95 A at 13.8 V	17.4 (.58 while idling)	47 VDC		
			AC TIG	5-125	90 A at 13.6 V	12.4 (.58 while idling)			
			DC stick	20-90	70 A at 22.8 V	20.5 (.58 while idling)			
		230 V	DC TIG	5-210	125 A at 15 V	11.9 (.35 while idling)			
			AC TIG	5-210	114 A at 14.6 V	8.62 (.35 while idling)			
			DC stick	20-150	90 A at 23.6 V	11.9 (.35 while idling)			



# Syncrowave® 300 and 400 AC/DC TIG and Stick

See literature AD/4.25 (300) and AD/4.28 (400)



Syncrowave 300 machine only

Syncrowave 400 TIGRunner

### TIG Welding Capability

400 Max. 15.9 mm (5/8 in.)	400 Max. 12.7 mm (1/2 in.)
300 Max. 12.7 mm (1/2 in.)	300 Max. 9.5 mm (3/8 in.)
Steel	Aluminum
Min. 0.3 mm (0.012 in.)	Min. 0.4 mm (0.015 in.)



### Processes

- TIG (GTAW) ▪ Stick (SMAW)
- DC pulsed TIG (GTAW-P)

### Comes with

- 3 m (10 ft.) power cord (no plug)
- Two 50 mm Dinse-style connectors

### Most popular accessories

- Coolant 043810



- **Weldcraft™ Water-Cooled Torch Kits**  
300990 W-280 (WP-280)  
301268 W-375
- **Remote Controls**  
043688 RCCS-14 fingertip control  
194744 RFCS-14 HD foot control  
301580 Wireless foot control

**Auto-Link®** circuit automatically links the power source to primary voltage being applied (208/240/480 V, single- or three-phase).

**AC balance control** features adjustable cleaning action while increasing arc stability on various aluminum alloys, and helps eliminate tungsten spitting and arc rectification.

**Blue Lightning™** high-frequency (HF) arc starter for non-contact arc initiation. Provides more consistent arc starts and greater reliability compared to traditional HF arc starters.

**Lift-Arc™** provides AC or DC arc initiation without the use of high frequency.

**Auto-postflow** adjusts the length of postflow time based on the amperage setting, shielding your tungsten and eliminating the need to set the postflow time.

**Pro-Set™** eliminates the guesswork when setting weld parameters. Use Pro-Set when you want the speed, convenience and confidence of preset controls.

**Arc timer/cycle counter** records actual welding time and number of arc starts. Great for estimating job costs.

**Line voltage compensation** keeps power source constant regardless of fluctuations in input power ( $\pm 10$  percent).

**Coolmate™ 3S cooler** (shown in TIGRunner). Three-gallon cooling system features a flow indicator to visually indicate system is working and an external filter to stop objects from entering the water-cooled torch cable.

<sup>1</sup>For Syncrowave 400 refer to owner's manual for 208 V output rating and duty cycle.

<sup>2</sup>Sense voltage for low OCV stick and Lift-Arc™ TIG.

<sup>3</sup>See literature AD/4.25 and AD/4.28 for Complete package dimensions and weight.

AC/DC	Model / Stock Number	Welding Process	Input Power	Welding Amp Range	Rated Output <sup>1</sup>	Amps Input at Rated Output, 50/60 Hz							Max. Open-Circuit Voltage	Power Source Dimensions <sup>2</sup>	Power Source Net Weight <sup>3</sup>			
						208 V	240 V	380 V	400 V	480 V	KVA	KW						
AC/DC	<b>Syncrowave 300</b> (907782) Power source only (907782001) TIGRunner (907782002) 380/400 V Power source only, <b>CE</b> (907782003) TIGRunner 380/400 V 50/60 Hz Power source/ Water cooler & Running gear, <b>CE</b>	TIG (includes cooler power draw)	3-phase	5-300	210 A at 18.4 V, 60% duty cycle	16	14	8.2	7.9	7	5.9	5.5	60 VDC (13 VDC <sup>2</sup> )	H: 746 mm (29.4 in.) W: 381 mm (15 in.) D: 625 mm (24.6 in.)	45.8 kg (101 lb.)			
			1-phase															
		Stick	3-phase	5-230	160 A at 26.4 V, 60% duty cycle	16	11	8.7	8.2	5	5.7	5.5						
			1-phase				27	23	-	-	11	5.7				5.5		
	<b>Syncrowave 400</b> (907783) Power source only (907783001) TIGRunner (907783002) 380/400 V Power source only, <b>CE</b> (907783003) TIGRunner 380/400 V 50/60 Hz Power source/ Water cooler & Running gear, <b>CE</b>	TIG (includes cooler power draw)	3-phase	5-400	300 A at 22 V, 60% duty cycle	25	23	13.7	12.4	11	9.1	8.8				70 VDC (13 VDC <sup>2</sup> )	H: 746 mm (29.4 in.) W: 381 mm (15 in.) D: 625 mm (24.6 in.)	59.4 kg (131 lb.)
			1-phase				43	42	-	-	20	9.7						
		Stick	3-phase	5-300	250 A at 30 V, 60% duty cycle	27	24	14.7	13.3	12	9.8	9.4						
			1-phase				47	43	-	-	21	10.4						



# Maxstar® 210/280 Series DC TIG and Stick

See literature DC/32.1 (210) and DC/35.0 (280)



Maxstar 210

Maxstar 280 DX

### TIG Welding Capability

<b>210 Max.</b> 6.4 mm (1/4 in.)
<b>Steel</b>
<b>210 Min.</b> 0.05 mm (0.002 in.)
<b>280 Max.</b> 9.5 mm (3/8 in.)
<b>Steel</b>
<b>280 Min.</b> 0.1 mm (0.004 in.)

**Base and DX models available.** Base model provides essential TIG and stick functions. DX models have extended ranges for sequencer, full trigger options, and full preflow and pulser functions.

**AUTO-LINE TECHNOLOGY** Allows for any input voltage hookup (210 models: 120–480 V, 280 models: 208–575 V) with no manual linking, providing convenience in any job setting. Ideal solution for dirty or unreliable power.

**Blue Lightning™** high-frequency (HF) arc starter for non-contact arc initiation. Provides more consistent arc starts and greater reliability compared to traditional HF arc starters.

**Lift-Arc™** provides DC arc initiation without the use of high frequency.

**Hot Start™** adaptive control provides positive arc starts without sticking.

**Auto-postflow** adjusts the length of postflow time based on the amperage setting, shielding your tungsten and eliminating the need to set the postflow time.

**Pro-Set™** eliminates the guesswork when setting weld parameters. Use Pro-Set when you want the speed, convenience and confidence of preset controls. Simply select the feature and adjust until Pro-Set appears on the display.

**Sleep timer** conserves electricity. This programmable feature will power down the machine if it sits idle for a specified time.

**Update and expand.** Front panel memory card data port provides the ability to easily update software and expand product features.

**Quiet Pulse™ (DX models only).** Activate Quiet Pulse by selecting sine or triangular waveshape to reduce audible noise.

**Optional cooler power supply (CPS) (available on Maxstar 280 only)** is an integrated 120-volt dedicated-use receptacle for the Coolmate™ 1.3.

**Cooler-On-Demand™ (CPS models only)** feature operates the auxiliary cooling system only when needed. Reduces noise, energy use, and airborne contaminants pulled through the cooler.

Industrial ● **CC DC 3 1**  
Phase Phase

### Processes

- TIG (GTAW) ▪ Stick (SMAW)
- Pulsed TIG (GTAW-P)
- Air carbon arc (CAC-A) with 280 model

### Comes with

- 2.4 m (8 ft.) power cord (no plug)
- Two 50 mm Dinse-style connectors

### TIGRunner® includes above plus

- Small Runner™ Cart
- Coolmate™ 1.3

### Most popular accessories

- 2-Wheel Trolley Cart 300971
- Small Runner™ Cart 301615
- Coolmate™ 1.3 301616
- Coolant 043810



### Contractor Kits

- 301309 A-150 w/RFCs-14 HD
- 301311 A-150 w/RCCS-14
- 301549 A-200 w/RFCs-14 HD
- 301550 A-200 w/RCCS-14



### Weldcraft™ Water-Cooled Torch Kits

- 300185 W-250 (WP-20)
- 300990 W-280 (WP-280)
- 301268 W-375
- Remote Controls
- 043688 RCCS-14 fingertip control
- 194744 RFCs-14 HD foot control
- 301580 Wireless foot control

\*Refer to owner's manual for complete ratings.  
\*\*Sense voltage for low OCV stick and Lift-Arc™ TIG.

Model/ Stock Number	Welding Process	Input Power	Welding Amp Range	Rated Output at 60% Duty Cycle	Amps Input at Rated Load Output, 50/60 Hz								Max. Open- Circuit Voltage	Dimensions	Net Weight		
					120 V	208 V	230 V	240 V	400 V	460 V	480 V	575 V				KVA	KW
<b>Maxstar 210</b> 907683 Power source only <b>Maxstar 210 DX</b> 907684 Power source only 907684001, CE	TIG	3-phase	1-210	210 A at 18.4 V	—	14	—	12	7	—	6	—	5.2	4.9	80 VDC (11 VDC**)	H: 346 mm (13.6 in.) W: 219 mm (8.6 in.) D: 495 mm (19.5 in.)	17.2 kg (38 lb.)
		1-phase	1-210	210 A at 18.4 V	—	24	—	20	12	—	10	—	4.9	4.9			
		1-phase (120 V)	1-150	125 A at 15 V	22	—	—	—	—	—	—	—	2.6	2.6			
	Stick	3-phase	5-210	160 A at 26.4 V	—	15	—	13	8	—	6	—	5.5	5.2			
		1-phase	5-210	160 A at 26.4 V	—	26	—	22	13	—	11	—	5.3	5.3			
		1-phase (120 V)	5-100	90 A at 23.6 V	23	—	—	—	—	—	—	—	2.8	2.8			
<b>Maxstar 280</b> 907552 Power source only 907538 Power source w/CPS 907538002 TIGRunner w/CPS <b>Maxstar 280 DX</b> 907553 Power source only 907539 Power source w/CPS 907539002 Power source only w/CPS, CE 907539001 TIGRunner w/CPS	TIG	3-phase	1-280	250 A at 20 V	—	21	19	—	11	9	—	7	7.6	7.3	60 VDC (11 VDC**)	H: 346 mm (13.6 in.) W: 219 mm (8.6 in.) D: 569 mm (22.5 in.)	21.3 kg (47 lb.) 22.7 kg (50 lb.) with CPS
		1-phase	1-280	250 A at 20 V	—	35	32	—	18	16	—	13	7.3	7.1			
		3-phase	5-280	250 A at 30 V	—	*	*	—	14	13	—	10	9.9	9.6			
	Stick	1-phase	5-280	180 A at 27.2 V	—	32	29	—	*	*	—	*	6.7	6.5			





# Dynasty® 210/300 Series AC/DC TIG and Stick

See literature AD/4.81 (210) and AD/4.96 (300)



Dynasty 210

Dynasty 300

### TIG Welding Capability

210 Max. 6.4 mm (1/4 in.)		210 Max. 6.4 mm (1/4 in.)	
Steel	Aluminum	Steel	Aluminum
210 Min. 0.05 mm (0.002 in.)	210 Min. 0.3 mm (0.012 in.)	210 Min. 0.05 mm (0.002 in.)	210 Min. 0.3 mm (0.012 in.)
300 Max. 9.5 mm (3/8 in.)		300 Max. 9.5 mm (3/8 in.)	
Steel	Aluminum	Steel	Aluminum
300 Min. 0.1 mm (0.004 in.)	300 Min. 0.3 mm (0.012 in.)	300 Min. 0.1 mm (0.004 in.)	300 Min. 0.3 mm (0.012 in.)

**Intuitive LCD display.** Ensures proper machine setup and parameter selection. Informative on-screen explanations and dynamic images enhance the parameter selection process.

**Program memory** allows easy naming, saving and recalling of favorite weld settings.

**Locks and limits** provide control of weld parameter ranges, minimizing deviation from the welding procedure specification (WPS).

**USB.** Front panel port provides the ability to easily update software, back-up settings and transfer saved weld programs from one unit to the next.

**AUTO-LINE TECHNOLOGY** Allows for any input voltage hookup (210 models: 120-480 V, 300 models: 208-600 V) with no manual linking, providing convenience in any job setting. Ideal solution for dirty or unreliable power.

**Blue Lightning™** high-frequency (HF) arc starter for non-contact arc initiation. Provides more consistent arc starts and greater reliability compared to traditional HF arc starters.

**Lift-Arc™** provides AC or DC arc initiation without the use of high frequency.

**Auto-postflow** adjusts the length of postflow time based on the amperage setting, shielding your tungsten and eliminating the need to set the postflow time.

**QUIETPULSE™** QuietPulse is activated by changing the waveshape for DC pulse welding to create a slower, more fluid transition between the background and peak amperage, resulting in lower audible noise.

**Pro-Set™** eliminates the guesswork when setting weld parameters. Use Pro-Set when you want the speed, convenience and confidence of preset controls. Simply select the feature and adjust until Pro-Set appears on the display.

**AC waveforms (TIG)** for advanced squarewave, soft squarewave, sine wave and triangular wave.

**AC balance (TIG)** control provides adjustable oxide removal which is essential for creating the highest quality aluminum welds.

**AC frequency (TIG)** controls the width of the arc cone and can improve directional control of the arc.

**Optional cooler power supply (CPS)** is an integrated 120-volt dedicated-use receptacle for the Coolmate™ 1.3.

**Cooler-On-Demand™ (CPS models only)** feature operates the auxiliary cooling system only when needed. Reduces noise, energy use, and airborne contaminants pulled through the cooler.

Industrial ● CC AC 3 1  
DC Phase Phase

### Processes

- TIG (GTAW) ▪ Stick (SMAW)
- Pulsed TIG (GTAW-P)
- Air carbon arc (CAC-A) with 300 model

### Comes with

- 2.4 m (8 ft.) power cord (no plug)
- Two 50 mm Dinse-style connectors

### TIGRunner® includes above plus

- Small Runner™ Cart
- Coolmate™ 1.3

### Complete packages include above plus

- Coolant (four 1-gallon bottles)
- Wireless foot remote control
- Weldcraft™ water-cooled torch kit  
Dynasty 210: W-250  
Dynasty 300: W-280

### Most popular accessories

- 2-Wheel Trolley Cart 300971
- Small Runner™ Cart 301615
- Coolmate™ 1.3 301616
- Coolant 043810

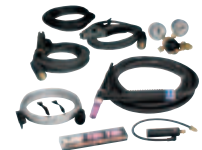

### Contractor Kits

- 301309 A-150 w/RFCs-14 HD
- 301311 A-150 w/RCCS-14
- 301549 A-200 w/RFCs-14 HD
- 301550 A-200 w/RCCS-14



### Weldcraft™ Water-Cooled Torch Kits

- 300185 W-250 (WP-20)
- 300990 W-280 (WP-280)
- 301268 W-375
- Remote Controls
- 043688 RCCS-14 fingertip control
- 194744 RFCs-14 HD foot control
- 301580 Wireless foot control

\*Additional packages are available – visit MillerWelds.com or your distributor.

\*\*Refer to owner's manual for complete ratings. \*\*\*Sense voltage for low OCV stick and Lift-Arc™ TIG.

AC/DC	Model/Stock Number*	Welding Process	Input Power	Welding Amp Range	Rated Output at 60% Duty Cycle	Amps Input at Rated Load Output, 50/60 Hz							Max. Open-Circuit Voltage	Dimensions	Net Weight		
						120 V	208 V	240 V	400 V	460 V	480 V	600 V				KVA	KW
	<b>Dynasty 210</b> 907816 Power source only 907816001 Power source w/CPS 907816002 TIGRunner w/CPS 907816003 Power source w/CPS, CE 907816004 TIGRunner, CE	TIG	3-phase	1-210	210 A at 18.4 V	–	16	14	8	–	7	–	5.7	5.2	80 VDC (11 VDC***)	H: 352 mm (13.88 in.) W: 216 mm (8.5 in.) D: 555 mm (21.88 in.)	21.3 kg (47 lb.) 22.7 kg (50 lb.) with CPS
			1-phase	1-210	210 A at 18.4 V	–	28	23	14	–	12	–	5.8	5.6			
			1-phase (120 V)	1-150	125 A at 15 V	26	–	–	–	–	–	–	2.8	2.7			
		Stick	3-phase	5-210	160 A at 26.4 V	–	16	14	9	–	8	–	6.0	5.8			
			1-phase	5-210	160 A at 26.4 V	–	28	24	14	–	12	–	6.4	5.5			
			1-phase (120 V)	5-100	90 A at 23.6 V	27	–	–	–	–	–	–	2.9	2.8			
	<b>Dynasty 300</b> 907818 Power source w/CPS 907818002 TIGRunner w/CPS 907818003 Power source w/CPS, CE 907818004 TIGRunner, CE	TIG	3-phase	2-300 (AC) 1-300 (DC)	250 A at 20 V	–	19	16	10	8	–	7	7.5	6.6	60 VDC (11 VDC***)	H: 352 mm (13.88 in.) W: 216 mm (8.5 in.) D: 555 mm (21.88 in.)	25 kg (55 lb.) with CPS
			1-phase	2-300 (AC) 1-300 (DC)	250 A at 20 V	–	33	29	17	15	–	11	6.7	6.7			
		Stick	3-phase	5-300	250 A at 30 V	–	**	**	14	12	–	9	9.8	9.1			
1-phase			5-300	200 A at 27.2 V	–	35	31	**	**	–	**	9.3	9.2				



## Maxstar® 400 and Dynasty® 400 and 800 DC (Maxstar) and AC/DC (Dynasty) TIG and Stick

See literature DC/24.5 (Maxstar) and AD/5.5 (Dynasty)



### TIG Welding Capability

800 Max. 25.4 mm (1 in.)	800 Max. 25.4 mm (1 in.)
400 Max. 15.9 mm (5/8 in.)	400 Max. 15.9 mm (5/8 in.)
Steel	Aluminum (Dynasty only)
400 Min. 0.3 mm (0.012 in.)	400 Min. 0.4 mm (0.015 in.)
800 Min. 0.5 mm (0.020 in.)	800 Min. 0.5 mm (0.020 in.)

**AUTO-LINE** TECHNOLOGY Allows for any input voltage hookup (208–575 V) with no manual linking, providing convenience in any job setting. Ideal solution for dirty or unreliable power.

**Blue Lightning™** high-frequency (HF) arc starter for non-contact arc initiation. Provides more consistent arc starts and greater reliability compared to traditional HF arc starters.

**Lift-Arc™** provides AC (Dynasty only) or DC arc initiation without the use of high frequency.

**Hot Start™** adaptive control provides positive arc starts without sticking.

**Auto-postflow** adjusts the length of postflow time based on the amperage setting, shielding your tungsten and eliminating the need to set the postflow time.

**QUIETPULSE™** QuietPulse is activated by changing the waveshape for DC pulse welding to create a slower, more fluid transition between the background and peak amperage, resulting in lower audible noise.

*Maxstar machines manufactured after serial number ND040985L include QuietPulse. Those manufactured before can be updated with QuietPulse™ Expansion Memory Card (301790).*

**Cooler power supply (CPS)** is an integrated 120-volt dedicated-use receptacle for the Coolmate™ 3.5.

**Program memory** features nine independent program memories that maintain/save your parameters.

**High-speed DC TIG pulse controls** capable of 5,000 pulses per second.

### Dynasty welders add AC TIG capabilities and the following AC features

**Waveforms** for advanced squarewave, soft squarewave, sine wave and triangular wave.

**Balance** control provides adjustable oxide removal which is essential for creating the highest quality aluminum welds.

**Frequency** controls the width of the arc cone and can improve directional control of the arc.

**AC amplitude/amperage** allows EP and EN amperages to be set independently to precisely control heat input to the work and electrode.

Heavy Industrial **CC** AC **3** DC Phase **1** Phase Maxstar is DC only

### Processes

- TIG (GTAW) ▪ Stick (SMAW)
- Pulsed TIG (GTAW-P)
- Air carbon arc (CAC-A)

### 400 models come with

- 2.4 m (8 ft.) power cord (no plug)
- Setup video and reference guide

*Note: Power cord is NOT included with 800 models.*

### Most popular accessories

- Runner™ Cart 300244
- Coolmate™ 3.5 300245
- Coolant 043810
- Remote Controls  
043688 RCCS-14 fingertip control  
194744 RFCS-14 HD foot control  
300429 Wireless Foot Control
- Dinse-style connector, Male 50 mm 134460

\*Sense voltage for low OCV stick and Lift-Arc™ TIG.

\*\*See literature DC/24.5 and AD/5.5 for Complete package dimensions and weight.

	Model/Stock Number	Welding Process	Input Power	Welding Amp Range	Rated Output at 60% Duty Cycle	Amps Input at 208 V	Rated Load Output, 50/60 Hz	Max. Open-Circuit Voltage	Power Source Dimensions**	Power Source Net Weight**
DC Maxstar	Maxstar 400 907716, CSA 907716001 TIGRunner, CSA 907716002, CE	TIG/stick	3-phase	3-400	300 A at 32 V	33 30 17 15 12 12.0 11.6	75 VDC (10-15 VDC*)	H: 629 mm (24.75 in.) W: 349 mm (13.75 in.) D: 559 mm (22 in.)	61 kg (134 lb.)	
			1-phase	3-400	250 A at 30 V	48 43 24 20 16 10 9.2				
AC/DC Dynasty	Dynasty 400 907717, CSA 907717001 TIGRunner, CSA 907717002, CE	TIG/stick	3-phase	3-400	300 A at 32 V	36 33 19 16 13 13.1 12.5	75 VDC (10-15 VDC*)	H: 629 mm (24.75 in.) W: 349 mm (13.75 in.) D: 559 mm (22 in.)	61 kg (134 lb.)	
			1-phase	3-400	250 A at 29 V	52 47 26 22 17 10.9 9.9				
AC/DC Dynasty	Dynasty 800 907719, CSA 907719001 TIGRunner, CSA 907719002, CE	TIG/stick	3-phase	5-800	600 A at 44 V	96 86 48 42 33 35 33	75 VDC (10-15 VDC*)	H: 876 mm (34.5 in.) W: 349 mm (13.75 in.) D: 559 mm (22 in.)	90 kg (198 lb.)	
			1-phase	5-800	500 A at 40 V	136 122 66 56 44 28 26				

# DYNASTY® SERIES SIMULATOR

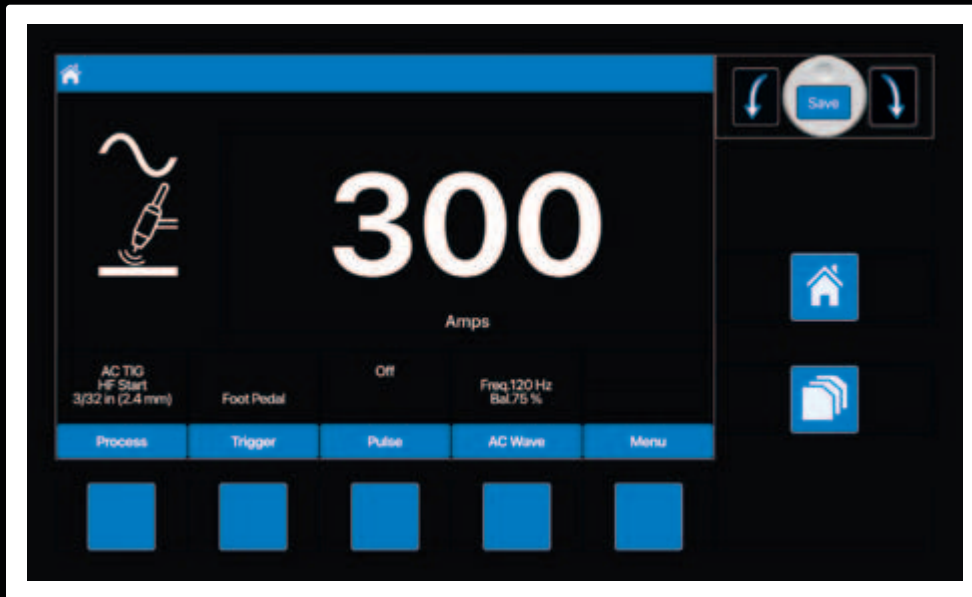

The simulator is a training tool and can be utilized for offline programming. Create a weld program on the online simulator, save it onto a USB, and plug the USB into the machine and start welding with the saved programs!

**NEW! Interactive Interface Simulator**

**TRY IT NOW >**

[TIG.MillerWelds.com/simulator](http://TIG.MillerWelds.com/simulator)

## RAISE EXPECTATIONS, NOT THE NOISE

Pulsed DC TIG welding at high pulses-per-second creates a distinctive “buzzing” sound that can be very annoying, especially in environments where there are multiple operators.

QuietPulse™ technology turns down the volume on the annoying sound that comes with pulsing so you can tune into the weld and focus on the job at hand.

**QUIETPULSE™**

Find out more at  
[MillerWelds.com/products/quietpulse](http://MillerWelds.com/products/quietpulse)







# TIG TORCHES

## Weldcraft™ Series TIG Torches

Synonymous with versatility and performance, Weldcraft TIG torches can handle the most intricate to the most demanding TIG welding challenges. From the 125-amp hand-held MicroTIG® torch to the 500-amp machine-held water-cooled models, there's a Weldcraft torch for nearly every TIG application.



For more detailed information, visit

[MillerWelds.com/tigtorches](http://MillerWelds.com/tigtorches)



### Setting the standard for performance

**Super Cool™ technology** provides additional surface area to increase cooling efficiency and capacity.

**Comfort and control** are increased with the lightweight, well-balanced body and handle designs, helping to reduce fatigue.

**Robust performance** through heavy copper construction that delivers maximum welding capacity for rugged fieldwork.

**Simplify torch package installation** with ColorSmart™ hose and cable sets that differentiate input water, water/power cable, and gas hoses.

**Improve gas coverage and cooling capacity** through the use of a gas lens.

### Extreme reliability

**Reduce downtime** due to overheating through consistent water-cooled performance.

**Extend parts life** using the durable copper components, maximizing current capacity.

**Reduce leakage** of gas and water through secure mechanical fittings.

**Works in cold weather** with the Tri-Flex™ hose and cable assembly that remains flexible to ease handling and extends cable life.

## TIG TORCH CONFIGURATOR

### MAKE SURE YOU ARE USING THE RIGHT TORCH AND CONSUMABLES FOR YOUR APPLICATION

Answer a few simple questions about your specific application and get a recommendation for the appropriate torch, tungsten, collet, collet body and more. Email or print the recommendation for reference when purchasing your next Weldcraft torch.

Visit now at [MillerWelds.com/torchconfig](http://MillerWelds.com/torchconfig)

**Miller Torch Product Selector**

Choose Products

- Torches Only
- Consumables Only
- Both Torches and Consumables

**Work Material**

- Mild Steel/Stainless Steel
- Deoxidized Copper
- Titanium
- Magnesium
- Aluminum

**Miller Torch Product Selector**

Part Number	Description	Quantity
WC332K7	2% Ceriated Tungsten (1/32" dia.)	1
S4NE3	Large Diameter SL Insulator	1
S3V8X3L	#10 Large Dia. SL Aluminum Nozzle XXL Long	1
S5N24	Collet for 3/32" dia. Tungsten	1
48V54	Large Gas Lens for 3/32" dia. Tungsten	1
20008	Medium Back Cap	1



## Weldcraft™ Air-Cooled Torches

**Recommended for welding amperages under 250 amps.** Air-cooled torches are great for portable applications as they do not require a water-circulator. For power sources without a built-in gas solenoid the air-cooled two-piece torch is the solution of choice.

## Weldcraft™ Water-Cooled Torches

**Recommended for welding amperages above 200 amps.** Offering a small torch design, water-cooled torches allow for precise control due to the efficient around-the-head cooling. This same cooling allows for extended torch life and higher amperage capacities.

## Weldcraft™ Specialty Torches

**Specialty torches are designed to fit best in unique applications.** The Modular Series torches allow for a quick change to many different torch styles for any joint configuration. For those hard-to-reach areas the W-125 MicroTIG® torch provides access and superior maneuverability.

## Weldcraft™ Automation Torches

**Ideal for mechanized applications,** the Weldcraft Automation Series offers air-cooled and water-cooled torches designed for low- and high-amperage mechanized applications.

### Process

- TIG (GTAW)

### Suggested power sources

- Multimatic® 215 (A-150)
- Multimatic® 220 AC/DC (A-150)
- Multimatic® 235 (A-150)
- Multimatic® 255 (A-150)
- Maxstar® 280 Multiprocess (A-200, A-250, W-280)
- Dynasty® 300 Multiprocess (A-200, A-250, W-280)
- XMT Series (A-200, A-250)
- CST™ 282 (A-250)
- Maxstar® 161 STL/STH (A-150)
- Syncrowave® 210 (A-150)
- Syncrowave® 300 (W-280)
- Syncrowave® 400 (W-375)
- Maxstar® 210 (A-150, W-250)
- Maxstar® 280 (A-200, A-250, W-280)
- Dynasty® 210 (A-150, W-250)
- Dynasty® 300 (A-200, A-250, W-280)
- Maxstar®/ Dynasty® 400 (W-375)
- Dynasty® 800 (W-400)

## Weldcraft™ A-80 Series

See literature AY/21.0

### Formerly known as WP-24 Series



**Innovative air-cooled torches designed for intricate welding applications, especially in limited-access areas and on thin-gauge materials.**

**Featherweight torch body** is well balanced to improve operator comfort and control.

**Minimize discontinuities.** Insulating gasket on torch body minimizes gas leakage and minimizes weld discontinuities.

**Combined flexible neck and gas valve (A-80 Flex Valve)** is ideal for optimal positioning and gas flow control.

### Applications

- Shipbuilding ▪ Motorsports
- Aerospace ▪ Restricted areas

### Most popular consumables

- Collets
  - 53N16 1.0 mm (.040 in.)
  - 53N14 1.6 mm (1/16 in.)
  - 24C332 2.4 mm (3/32 in.)
- Collet Bodies
  - 53N18 1.0 mm (.040 in.)
  - 53N19 1.6 mm (1/16 in.)
  - 24CB332 2.4 mm (3/32 in.)
- Alumina Nozzles
  - A53N24 #4, 6.4 mm (1/4 in.)
  - A53N25 #5, 7.9 mm (5/16 in.)
  - A53N27 #6, 9.5 mm (3/8 in.)

### Most popular accessories

- Collet Body Wrench 53N20

Model	Rubber 3.8 m (12.5 ft.)	7.6 m (25 ft.)	Type	Rated Output	Electrode Range
A-80 Flex	WP-24F-12-R	WP-24F-25-R	Air-cooled	DC: 80 A at 60% duty cycle AC: 50 A at 60% duty cycle	0.5-2.4 mm (.020-3/32 in.)
A-80 Flex Valve	WP-24FV-12-R	WP-24FV-25-R			



# TIG TORCHES AIR-COOLED

## Weldcraft™ A-125 Series

See literature AY/22.0

Formerly known as WP-9 Series



**Air-cooled torches designed for optimal control while welding thin-gauge materials, especially in hard-to-reach places.**

**Lightweight body** reduces fatigue and downtime, while increasing operator comfort.

**Pencil-style model (A-125 Pencil)** without a back cap allows for superior access to confined areas.

**Combined flexible neck and gas valve (A-125 Flex Valve)** for welding limited-access joints using power sources without gas solenoids.

### Applications

- Maintenance and repair
- Motorsports
- Metal art • Fabrication

### Most popular consumables

- Collets
  - 13N22 1.6 mm (1/16 in.)
  - 13N23 2.4 mm (3/32 in.)
  - 13N24 3.2 mm (1/8 in.)
- Collet Bodies
  - 13N27 1.6 mm (1/16 in.)
  - 13N28 2.4 mm (3/32 in.)
  - 13N29 3.2 mm (1/8 in.)
- Alumina Nozzles
  - 13N10 #6, 9.5 mm (3/8 in.)
  - 13N11 #7, 11.1 mm (7/16 in.)
  - 13N12 #8, 12.7 mm (1/2 in.)

### Most popular accessories

- Accessory Kit AK1C

Model	Rubber 3.8 m (12.5 ft.)		2-Piece Rubber 3.8 m (12.5 ft.)		Type	Rated Output	Electrode Range
	7.6 m (25 ft.)	7.6 m (25 ft.)	3.8 m (12.5 ft.)	7.6 m (25 ft.)			
A-125	WP-9-12-R	WP-9-25-R	—	—	Air-cooled	DC: 125 A at 60% duty cycle AC: 100 A at 60% duty cycle	0.5-3.2 mm (.020-1/8 in.)
A-125 Valve	WP-9V-12-R	WP-9V-25-R	—	WP-9V-25-2			
A-125 Flex	WP-9F-12-R	WP-9F-25-R	WP-9F-12-2	WP-9F-25-2			
A-125 Flex Valve	WP-9FV-12-R	WP-9FV-25-R	—	WP-9FV-25-2			
A-125 Pencil	WP-9P-12-R	WP-9P-25-R	—	—			

## Weldcraft™ A-150 Series

See literature AY/23.0

Formerly known as WP-17 Series

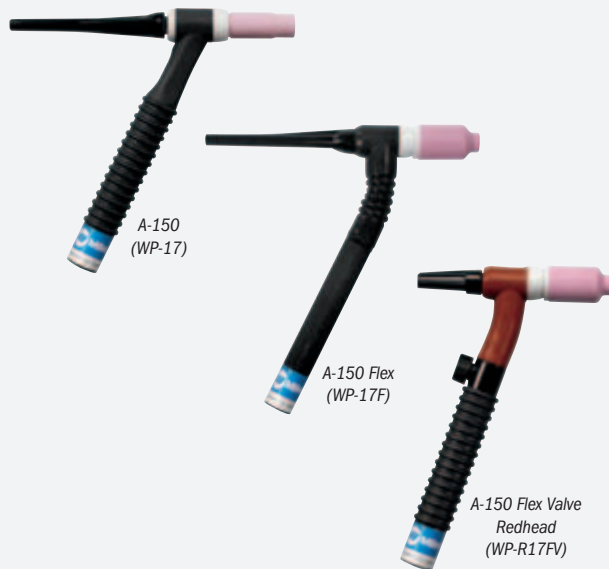

**Versatile and innovative air-cooled torches designed for maximum comfort in a variety of applications.**

**Diamond Grip™ head design (A-150 and A-150 Valve)** has ergonomic contact points for thumb and fingers. Provides a more comfortable grip and reduces operator fatigue.

**Improve control and comfort (A-150 Flex)** with a flexible neck that allows access into hard-to-reach areas.

**Maximum versatility.** Utilize the Redhead™ Series torches in a variety of welding applications without adding expenses.

### Applications

- Fabrication • Maintenance and repair
- Aerospace • Food/beverage industry
- Metal art • Petro/chemical
- Shipbuilding

### Most popular consumables

- Collets
  - 10N23 1.6 mm (1/16 in.)
  - 10N24 2.4 mm (3/32 in.)
  - 10N25 3.2 mm (1/8 in.)
- Collet Bodies
  - 10N31 1.6 mm (1/16 in.)
  - 10N32 2.4 mm (3/32 in.)
  - 10N28 3.2 mm (1/8 in.)
- Alumina Nozzles
  - 10N48 #6, 9.5 mm (3/8 in.)
  - 10N47 #7, 11.1 mm (7/16 in.)
  - 10N46 #8, 12.7 mm (1/2 in.)

### Most popular accessories

- Accessory Kit AK-150MFC  
Converts A-150 into 28 different torch styles while using existing cable - includes collets, collet bodies, nozzles, torch heads, handle and more.

Model	Rubber 3.8 m (12.5 ft.)		Mono-Flex™ 3.8 m (12.5 ft.)		2-Piece Rubber 3.8 m (12.5 ft.)		Type	Rated Output	Electrode Range
	7.6 m (25 ft.)	7.6 m (25 ft.)	3.8 m (12.5 ft.)	7.6 m (25 ft.)	3.8 m (12.5 ft.)	7.6 m (25 ft.)			
A-150	WP-17-12-R	WP-17-25-R	WP-17-12-MF	WP-17-25-MF	WP-17-12-2	WP-17-25-2	Air-cooled	DC: 150 A at 60% duty cycle AC: 115 A at 60% duty cycle	0.5-3.2 mm (.020-1/8 in.)
A-150 Valve	WP-17V-12-R	WP-17V-25-R	WP-17V-12-MF	WP-17V-25-MF	WP-17V-12-2	WP-17V-25-2			
A-150 Flex	WP-17F-12-R	WP-17F-25-R	—	—	—	WP-17F-25-2			
A-150 Flex Valve	WP-17FV-12-R	WP-17FV-25-R	—	—	WP-17FV-12-2	WP-17FV-25-2			
A-150 Flex Valve Redhead	WP-R17FV-12-R	WP-R17FV-25-R	—	—	—	—			





## Weldcraft™ A-200 Series

Formerly known as WP-26 Series

See literature AY/24.0



A-200  
(WP-26)

A-200 Flex  
Valve  
(WP-26FV)

**Dependable, top-performing air-cooled torches designed for heavy-duty welding applications.**

**Eliminate the expense** of a water-cooled system. The air-cooled capability of the A-200 Series pairs reliability with cost-effectiveness for all field applications.

**Combined flexible neck and gas valve (A-200 Flex Valve)** advances capabilities with greater comfort and control.

**Maximum versatility.** Utilize the Redhead Series torches in a variety of welding applications without adding expenses.

### Applications

- Fabrication ▪ Maintenance and repair
- Manufacturing ▪ Shipbuilding
- Vocational

### Most popular consumables

- Collets
  - 10N23 1.6 mm (1/16 in.)
  - 10N24 2.4 mm (3/32 in.)
  - 10N25 3.2 mm (1/8 in.)
- Collet Bodies
  - 10N31 1.6 mm (1/16 in.)
  - 10N32 2.4 mm (3/32 in.)
  - 10N28 3.2 mm (1/8 in.)
- Alumina Nozzles
  - 10N47 #7, 11.1 mm (7/16 in.)
  - 10N46 #8, 12.7 mm (1/2 in.)
  - 10N45 #10, 15.9 mm (5/8 in.)

### Most popular accessories



- **Gas Lens Kit AK3GL**  
Includes one short back cap, one of each size (#6, #7, #8) alumina nozzle, and one of each size (1/16, 3/32, 1/8 inch) of the following: gas lens, collet, and 7-inch 2% ceriated tungsten electrode.



- **Accessory Kit AK3C**  
Includes one short back cap, one of each size (#5, #6, #8) alumina nozzle, and one of each size (1/16, 3/32, 1/8 inch) of the following: collet, collet body, and 7-inch 2% ceriated tungsten electrode.

Model	Rubber 3.8 m (12.5 ft.)		2-Piece Rubber 3.8 m (12.5 ft.)		Type	Rated Output	Electrode Range
	7.6 m (25 ft.)	7.6 m (25 ft.)	3.8 m (12.5 ft.)	7.6 m (25 ft.)			
A-200	WP-26-12-R	WP-26-25-R	WP-26-12-2	WP-26-25-2	Air-cooled	DC: 200 A at 60% duty cycle AC: 150 A at 60% duty cycle	0.5-4.0 mm (.020-5/32 in.)
A-200 Valve	WP-26V-12-R	WP-26V-25-R	WP-26V-12-2	WP-26V-25-2			
A-200 Flex	WP-26F-12-R	WP-26F-25-R	—	WP-26F-25-2			
A-200 Flex Valve	WP-26FV-12-R	WP-26FV-25-R	WP-26FV-12-2	WP-26FV-25-2			
A-200 Flex Redhead	WP-R26F-12-R	—	—	—			
A-200 Flex Valve Redhead	—	WP-R26FV-25-R	—	—			

## Weldcraft™ A-250 Series

See literature AY/24.5



A-250

A-250  
Valve

**Dependable, top-performing air-cooled torches designed for heavy-duty welding applications.**

**Eliminate the expense** of a water-cooled system. The air-cooled capability of the A-250 Series pairs reliability with cost-effectiveness for all field applications.

**Robust performance.** The heavy copper construction delivers optimal welding capacity for rugged fieldwork.

**Effortless adjustments (A-250 Valve).** Gas control valve ensures quick and easy adjustment of shielding gas flow.

Model	2-Piece Rubber, 7.6 m (25 ft.)	Type	Rated Output	Electrode Range
A-250	301525025	Air-cooled	DC: 250 A at 60% duty cycle AC: 188 A at 60% duty cycle	0.5-4.0 mm (.020-5/32 in.)
A-250 Valve	301526025			

# THE GARAGE PROJECT SHOW THAT KEEPS IT REAL

New year, same Andy. Real Garage with Andy is back, and the transformation of the 1969 Trans Am is taking shape! Don't miss a project, tip or weld — catch all the episodes on the Real Garage YouTube channel.



Scan the QR code to watch and subscribe





# TIG TORCHES WATER-COOLED

## Weldcraft™ W-180

See literature AY/26.0

Formerly known as WP-24W



**One of the smallest water-cooled TIG torches on the market and designed for welding in confined areas that require high amperage.**

**Use high amperage in confined areas** for efficient welding.

**Superior maneuverability** in limited-access locations with the compact torch body.

**Excellent weld capacity** without increasing torch size, due to the efficient cooling system.

### Applications

- Aerospace ▪ Manufacturing
- Food/beverage industry ▪ Shipbuilding
- Maintenance and repair
- Petro/chemical ▪ Precision fabrication

### Most popular consumables

- Collets
  - 53N16 1.0 mm (.040 in.)
  - 53N14 1.6 mm (1/16 in.)
  - 24C332 2.4 mm (3/32 in.)
- Collet Bodies
  - 53N18 1.0 mm (.040 in.)
  - 53N19 1.6 mm (1/16 in.)
  - 24CB332 2.4 mm (3/32 in.)
- Alumina Nozzles
  - A53N24 #4, 6.4 mm (1/4 in.)
  - A53N25 #5, 7.9 mm (5/16 in.)
  - A53N27 #6, 9.5 mm (3/8 in.)

Model	Braided Rubber, 7.6 m (25 ft.)	Vinyl, 7.6 m (25 ft.)	Type	Rated Output	Electrode Range
W-180	WP-24W-25-R	WP-24W-25	Water-cooled	DC: 180 A at 100% duty cycle, AC: 115 A at 100% duty cycle	0.5-2.4 mm (.020-3/32 in.)

## Weldcraft™ W-200 Pencil Flex

See literature AY/27.0

Formerly known as WP-25



**Versatile water-cooled torch optimized for use in limited-access welding situations.**

**Pencil-style with flexible neck** designed for both high-amperage applications and confined-area access.

**Decreased downtime and longer trouble-free service** due to overheating with the innovative cooling design.

**Comfort and control** are increased with the lightweight, well-balanced body design.

### Applications

- Aerospace ▪ Aluminum fabrication
- Automotive ▪ Manufacturing
- Exotic material fabrication
- Precision metal fabrication
- Pressure vessel fabrication
- Shipbuilding ▪ Tool and die
- Tube and pipe ▪ Vocational

### Most popular consumables

- Insulator (non-gas lens and gas lens) (required) 598882
- Collets (non-gas lens and gas lens)
  - 13N21 1.0 mm (.040 in.)
  - 13N22 1.6 mm (1/16 in.)
  - 13N23 2.4 mm (3/32 in.)
  - 13N24 3.2 mm (1/8 in.)
- Collet Bodies
  - 13N26 1.0 mm (.040 in.)
  - 13N27 1.6 mm (1/16 in.)
  - 13N28 2.4 mm (3/32 in.)
  - 13N29 3.2 mm (1/8 in.)

Model	Braided Rubber 3.8 m (12.5 ft.)	7.6 m (25 ft.)	Vinyl 3.8 m (12.5 ft.)	7.6 m (25 ft.)	Type	Rated Output	Electrode Range
W-200 Pencil Flex	WP-25-12-R	WP-25-25-R	WP-25-12	WP-25-25	Water-cooled	DC: 200 A at 100% duty cycle AC: 140 A at 100% duty cycle	0.5-3.2 mm (.020-1/8 in.)

## Weldcraft™ W-250 Series

See literature AY/29.0

Formerly known as WP-20 Series



**Water-cooled torches that provide consistent performance and long-term trouble-free service with around-the-head water cooling.**

**Extend torch life and minimize downtime** due to overheating with the efficient around-the-head cooling design.

**Reduce leakage** of gas and water through secure mechanical fittings and connections.

**Easy hose replacement (W-250 Valve)** with the innovative mechanical fittings design.

- Gas Lenses
  - 45V42 1.0 mm (.040 in.)
  - 45V43 1.6 mm (1/16 in.)
  - 45V44 2.4 mm (3/32 in.)
  - 45V45 3.2 mm (1/8 in.)
- Alumina Nozzles
  - 13N08 #4, 6.4 mm (1/4 in.)
  - 13N09 #5, 7.9 mm (5/16 in.)
  - 13N10 #6, 9.5 mm (3/8 in.)
  - 13N11 #7, 11.1 mm (7/16 in.)
  - 13N12 #8, 12.7 mm (1/2 in.)
  - 13N13 #10, 15.9 mm (5/8 in.)
  - 53N58 #4, 6.4 mm (1/4 in.) (gas lens)
  - 53N59 #5, 7.9 mm (5/16 in.) (gas lens)
  - 53N60 #6, 9.5 mm (3/8 in.) (gas lens)
  - 53N61 #7, 11.1 mm (7/16 in.) (gas lens)
  - 53N61S #8, 12.7 mm (1/2 in.) (gas lens)

### Most popular accessories

- Cable Covers
  - WC-3-10 3 m (10 ft.)
  - WC-3-22 6.7 m (22 ft.)

Model	Braided Rubber 3.8 m (12.5 ft.)	7.6 m (25 ft.)	Vinyl 3.8 m (12.5 ft.)	7.6 m (25 ft.)	Type	Rated Output	Electrode Range
W-250	WP-20-12-R	WP-20-25-R	WP-20-12	WP-20-25	Water-cooled	DC: 250 A at 100% duty cycle AC: 180 A at 100% duty cycle	0.5-3.2 mm (.020-1/8 in.)
W-250 Valve	—	—	—	WP-20V-25			



## Weldcraft™ W-280 Super Cool™

See literature AY/30.0

Formerly known as WP-280



**Reliable water-cooled torch designed for demanding, high-amperage applications.**

**Super Cool technology** provides additional surface area to increase cooling efficiency and capacity.

**Reduce downtime** due to overheating through consistent water-cooled performance.

**Reduce leakage** of gas and water through secure mechanical fittings and connections.

Model	Braided Rubber 3.8 m (12.5 ft.)		Braided Rubber with 50 mm Dinse 7.6 m (25 ft.)	Type	Rated Output	Electrode Range
	7.6 m (25 ft.)	301251012				
W-280 Super Cool	301251012	301251025	301251001	Water-cooled	DC: 280 A at 100% duty cycle AC: 195 A at 100% duty cycle	0.5-3.2 mm (.020-1/8 in.)

## Weldcraft™ W-375 Super Cool™

See literature AY/32.5



**Reliable water-cooled torch designed for demanding, high-amperage applications.**

**Super Cool technology** provides additional surface area to increase cooling efficiency and capacity.

**Reduce downtime** due to overheating through consistent water-cooled performance.

**Reduce leakage** of gas and water through secure mechanical fittings and connections.

Model	Braided Rubber 3.8 m (12.5 ft.)		Braided Rubber with 50 mm Dinse 7.6 m (25 ft.)	Type	Rated Output	Electrode Range
	7.6 m (25 ft.)	301253012				
W-375 Super Cool	301253012	301253025	301253001	Water-cooled	DC: 375 A at 100% duty cycle AC: 265 A at 100% duty cycle	0.5-3.2 mm (.020-1/8 in.)

## Weldcraft™ W-350 Series

See literature AY/32.0

Formerly known as WP-18 Series



W-350  
(WP-18)



W-350 Valve  
(WP-18V)

**Rugged water-cooled torches engineered for high-amperage and continuous hand-held welding.**

**Reduce downtime and costs** by minimizing overheating with the unique cooling design engineered for operator comfort.

**Reduce discomfort and fatigue** using the comfortable handle design.

**Superior gas flow control (W-350 Valve)** offered through the built-in fingertip gas control.

Model	Rubber 3.8 m (12.5 ft.)		Vinyl 3.8 m (12.5 ft.)		Type	Rated Output	Electrode Range
	7.6 m (25 ft.)	WP-18-12-R	WP-18-25-R	WP-18-25			
W-350	WP-18-12-R	WP-18-25-R	WP-18-12	WP-18-25	Water-cooled	DC: 350 A at 100% duty cycle AC: 250 A at 100% duty cycle	0.5-4.0 mm (.020-5/32 in.)
W-350 Valve	—	WP-18V-25-R	—	WP-18V-25			

### Applications

- Aerospace ▪ Aluminum fabrication
- Automotive ▪ Manufacturing
- Exotic material fabrication
- Precision metal fabrication
- Pressure vessel fabrication
- Shipbuilding ▪ Tool and die
- Tube and pipe ▪ Vocational

### Most popular consumables

- Insulator (non-gas lens and gas lens) (required) 598882
- Collets (non-gas lens and gas lens)
  - 13N21 1.0 mm (.040 in.)
  - 13N22 1.6 mm (1/16 in.)
  - 13N23 2.4 mm (3/32 in.)
  - 13N24 3.2 mm (1/8 in.)
- Collet Bodies
  - 13N26 1.0 mm (.040 in.)
  - 13N27 1.6 mm (1/16 in.)
  - 13N28 2.4 mm (3/32 in.)
  - 13N29 3.2 mm (1/8 in.)
- Gas Lens
  - 45V42 1.0 mm (.040 in.)
  - 45V43 1.6 mm (1/16 in.)
  - 45V44 2.4 mm (3/32 in.)
  - 45V45 3.2 mm (1/8 in.)
- Alumina Nozzles
  - 13N08 #4, 6.4 mm (1/4 in.)
  - 13N09 #5, 7.9 mm (5/16 in.)
  - 13N10 #6, 9.5 mm (3/8 in.)
  - 13N11 #7, 11.1 mm (7/16 in.)
  - 13N12 #8, 12.7 mm (1/2 in.)
  - 13N13 #10, 15.9 mm (5/8 in.)
  - 53N58 #4, 6.4 mm (1/4 in.) (gas lens)
  - 53N59 #5, 7.9 mm (5/16 in.) (gas lens)
  - 53N60 #6, 9.5 mm (3/8 in.) (gas lens)
  - 53N61 #7, 11.1 mm (7/16 in.) (gas lens)
  - 53N61S #8, 12.7 mm (1/2 in.) (gas lens)
- Back Caps
  - 41V33 Short
  - 41V35 Medium
  - 41V24 Long

### Applications

- Fabrication ▪ Manufacturing
- Maintenance and repair
- Shipbuilding ▪ Tube and pipe

### Most popular consumables

- Collets
  - 10N24 2.4 mm (3/32 in.)
  - 10N25 3.2 mm (1/8 in.)
  - 54N20 4.0 mm (5/32 in.)
- Collet Bodies
  - 10N32 2.4 mm (3/32 in.)
  - 10N28 3.2 mm (1/8 in.)
  - 406488 4.0 mm (5/32 in.)
- Alumina Nozzles
  - 10N48 #6, 9.5 mm (3/8 in.)
  - 10N47 #7, 11.1 mm (7/16 in.)
  - 10N46 #8, 12.7 mm (1/2 in.)
  - 10N45 #10, 15.9 mm (5/8 in.)
  - 10N44 #12, 19 mm (3/4 in.)





# TIG TORCHES WATER-COOLED AND SPECIALTY

## Weldcraft™ W-400 Super Cool™

See literature AY/33.0

Formerly known as WP-18SC



**Water-cooled torch designed to endure some of the most demanding applications while minimizing overheating.**

**Extend torch and consumable life** with the full-flow water chamber that provides around-the-head cooling.

**Improve gas coverage and cooling capacity** with gas lens usage with heavy-duty stubby collet body.

**Extend parts life** using the durable copper components, maximizing current capacity.

### Applications

- Heavy fabrication ▪ Tool and die
- Pipe and tube fabrication
- Pressure vessel fabrication

### Most popular consumables

- Heavy-Duty Collets
  - 10N25HD 3.2 mm (1/8 in.)
  - 54N20HD 4.0 mm (5/32 in.)
  - 18C36 4.8 mm (3/16 in.)
- Heavy-Duty Nose Collet Body (all sizes) NCB-36
- Alumina Nozzles
  - 54N16 #6, 9.5 mm (3/8 in.)
  - 54N15 #7, 11.1 mm (7/16 in.)
  - 54N14 #8, 12.7 mm (1/2 in.)
- Back Caps
  - 57Y04 Short
  - 300M Medium

Model	Rubber, 7.6 m (25 ft.)	Vinyl, 7.6 m (25 ft.)	Type	Rated Output	Electrode Range
W-400 Super Cool	WP-18SC-25-R	WP-18SC-25	Water-cooled	DC: 400 A at 100% duty cycle, AC: 280 A at 100% duty cycle	0.5-4.8 mm (.020-3/16 in.)

## Weldcraft™ Modular Series

See literature AY/36.0



**Air-cooled and water-cooled torches engineered to weld multiple joint configurations for various applications and angles.**

**Built-in, efficient cooling system** reduces overheating to extend parts and consumable life.

**Modular design** minimizes costs and downtime for torch changeover and parts inventory.

**Easy configurable head options** provide greater flexibility and joint access, minimizing downtime for torch changeover.

**Gas valve (A-150 Modular Valve)** provides greater shielding gas flow control.

### Applications

- Maintenance and repair ▪ Aerospace
- Metal art ▪ Food/beverage industry
- Petro/chemical ▪ Shipbuilding
- Manufacturing ▪ Vocational
- Precision fabrication ▪ Tube and pipe

### Most popular accessories



### Accessory Kit

- AK-150MFC For A-150 torch
- AK-225MFC For W-225 torch

Model	Rubber 3.8 m (12.5 ft.)	7.6 m (25 ft.)	Type	Rated Output (Torch head dependent)	Electrode Range (Torch head dependent)	
A-150 Modular	WP-150-12-R	WP-150-25-R	Air-cooled	DC: 150 A at 60% duty cycle AC: 105 A at 60% duty cycle	0.5-3.2 mm (.020-1/8 in.)	
A-150 Modular Valve	WP-150V-12-R	WP-150V-25-R				
Model	Braided Rubber 3.8 m (12.5 ft.)	7.6 m (25 ft.)	Vinyl 7.6 m (25 ft.)	Type	Rated Output (Torch head dependent)	Electrode Range (Torch head dependent)
W-225 Modular	WP-225-12-R	WP-225-25-R	WP-225-25	Water-cooled	DC: 225 A at 100% duty cycle AC: 160 A at 100% duty cycle	0.5-4.0 mm (.020-5/32 in.)

## Weldcraft™ W-125 Long Micro

See literature AY/25.0

Formerly known as WP-125L



**Water-cooled MicroTIG® torch designed for limited-access joints.**

**Small 127 mm (5 in.) torch body** designed for limited-access joints.

**Low-profile nozzle** fits into holes as small as 5/8-inch diameter.

**45-degree, 90-degree, and 180-degree options** improve access in tight areas.

**Lower maintenance costs** incurred with the replaceable silicone rubber insulator and head components.

### Applications

- Aerospace ▪ Food/beverage industry
- HVAC ▪ Automotive ▪ Petro/chemical
- Precision fabrication

### Most popular consumables

- 90° Chucks
  - 125C40-90 1.0 mm (.040 in.)
  - 125C116-90 1.6 mm (1/16 in.)
  - 125C332-90 2.4 mm (3/32 in.)
- 90° Glass Nozzle (all sizes)
  - 125N90 (other nozzles are available)



Model	Braided Rubber, 3.8 m (12.5 ft.)	Type	Rated Output	Electrode Range
W-125 Long Micro	WP-125L-25-R	Water-cooled	DC: 125 A at 100% duty cycle AC: 80 A at 100% duty cycle	1.0-2.4 mm (.040-3/32 in.)



## Weldcraft™ Automation Series

See literature AY/37.0

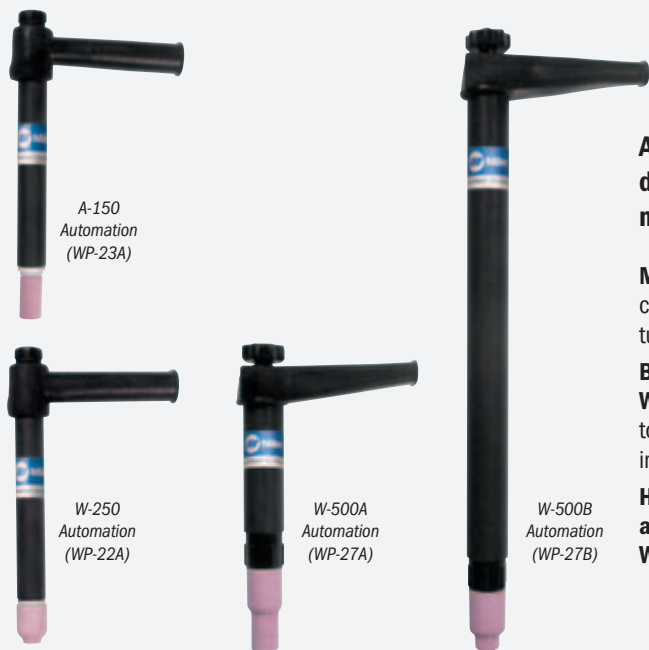

**Air-cooled and water-cooled torches designed for low- and high-amperage mechanized applications.**

**Minimize downtime** associated with tungsten changeover by using the front or back tungsten loading areas.

**Built-in gas lens (W-500A Automation and W-500B Automation)** improves gas coverage to minimize shielding gas turbulence and improve weld quality.

**Handle the most demanding high-amperage applications (W-500A Automation and W-500B Automation).**

### Applications

- Aerospace
- Food/beverage industry
- Pressure vessel fabrication
- Petro/chemical

### Most popular accessories

- Cable Covers
  - WC-3-10 3 m (10 ft.)
  - WC-3-22 6.7 m (22 ft.)
  - WC-4-10 3 m (10 ft.)
  - WC-4-22 6.7 m (22 ft.)



- **Air-Cooled Torch 1-Piece Power Cable Connector**  
195378 50 mm Dinse-style



- **Water-Cooled Torch 1-Piece Power Cable Connectors**  
195377 50 mm Dinse-style  
225028 50 mm thread-lock

Model	Rubber, 3.8 m (12.5 ft.)		2-Piece Rubber, 3.8 m (12.5 ft.)			Type	Rated Output	Electrode Range
A-150 Automation	WP-23A-12-R		WP-23A-12-2			Air-cooled	DC: 150 A at 60% duty cycle AC: 120 A at 60% duty cycle	1.0-2.4 mm (.040-3/32 in.)
Model	Rubber 0.9 m (3 ft.)	3.8 m (12.5 ft.)	Vinyl 0.9 m (3 ft.)	3.8 m (12.5 ft.)	7.6 m (25 ft.)	Type	Rated Output	Electrode Range
W-250 Automation	—	—	WP-22A-3	WP-22A-12	WP-22A-25	Water-cooled	DC: 250 A at 100% duty cycle AC: 180 A at 100% duty cycle	1.0-3.2 mm (.040-1/8 in.)
W-500A Automation	WP-27A-3	WP-27A-12	—	—	—	Water-cooled	DC: 500 A at 100% duty cycle AC: 350 A at 100% duty cycle	1.0-6.4 mm (.040-1/4 in.)
W-500B Automation	WP-27B-3	WP-27B-12	—	—	—	Water-cooled	DC: 500 A at 100% duty cycle AC: 350 A at 100% duty cycle	1.0-6.4 mm (.040-1/4 in.)

## Weldcraft™ Tungsten

### Tungsten for the most demanding TIG welding applications!

Available in four types and industry-standard diameters, our line of Weldcraft tungsten electrodes has undergone rigorous testing to ensure the highest quality and durability. Color-coded packages include ten 175 mm (7 in.) tungsten electrodes.

Type	Stock Number	Diameter mm (in.)	Type	Stock Number	Diameter mm (in.)
<b>2% Ceriated (EWCe-2)</b>			<b>Pure (EWP)</b>		
Performs well in DC welding and arc starting at low-current settings. Offers excellent performance in AC processes.	WC040X7	1.0 (0.040)	Forms a clean, balled end when heated. Provides good arc stability for AC welding with a balanced or unbalanced squarewave or sine wave.	—	1.0 (0.040)
	WC116X7	1.6 (1/16)		WP116X7	1.6 (1/16)
	WC332X7	2.4 (3/32)		WP332X7	2.4 (3/32)
	WC018X7	3.2 (1/8)		WP018X7	3.2 (1/8)
	WC532X7	4.0 (5/32)		—	4.0 (5/32)
<b>2% Lanthanated (EWLa-2)</b>			<b>Rare Earth (EWG)</b>		
Provides excellent arc starting, arc stability and re-ignition, and less tip erosion in AC or DC welding. Can substitute for 2% Thoriated.	WL2040X7	1.0 (0.040)	Combines the best of all alloying elements, and provides excellent arc stability in AC or DC welding.	—	1.0 (0.040)
	WL2116X7	1.6 (1/16)		WG116X7	1.6 (1/16)
	WL2332X7	2.4 (3/32)		WG332X7	2.4 (3/32)
	WL2018X7	3.2 (1/8)		WG018X7	3.2 (1/8)
	WL2532X7	4.0 (5/32)			—



Note: Refer to manufacturer SDS sheets for proper preparation and safety. Use proper ventilation/capture during preparation. Refer to manufacturer warning regarding ventilation.



## Weldcraft™ TIG Torch Accessories

### GL Kits (Gas Lens Kits)

Gas lenses improve the gas coverage of the tungsten during the TIG welding process. They can save you time and money by increasing your weld quality while using less gas. GL kits provide three different-sized gas lenses and consumables in each kit to work with a variety of different applications.



**AK3GL**  
For A-150 Series, A-200 Series and A-250 Series. Includes one short back cap, one of each size (#6, #7, #8)

alumina nozzle, and one of each size (1/16, 3/32, 1/8 inch) of the following: gas lens, collet, and 7-inch 2% ceriated tungsten electrode.



**AK4GL**  
For W-200 Pencil Flex, W-225 Modular, W-250 Series, W-280 Super Cool and W-375 Super Cool. Includes one short

back cap, one of each size (#6, #7, #8) alumina nozzle, and one of each size (1/16, 3/32, 1/8 inch) of the following: gas lens, collet, and 7-inch 2% ceriated tungsten electrode.

### AK Kits (Accessory Kits)

AK kits provide a set of different consumables for Weldcraft torches to tackle a variety of different applications. Kits include nozzles, collets, collet bodies, tungsten and back caps.



**AK1C**  
For A-125 Series. Includes one long back cap, one of each size (#4, #5, #6)

alumina nozzle, and one of each size (.040, 1/16 inch) of the following: collet, collet body, and 7-inch 2% ceriated tungsten electrode.

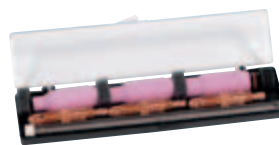

**AK2C**  
For A-150 Series. Includes one short back cap, one of each size (#4, #5, #6) alumina nozzle, and one of each

size (.040, 1/16, 3/32 inch) of the following: collet, collet body, and 7-inch 2% ceriated tungsten electrode.

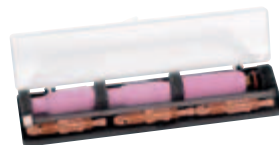

**AK3C**  
For A-200 Series, A-250 Series and W-350 Series. Includes one short back cap, one of each size

(#5, #6, #8) alumina nozzle, and one of each size (1/16, 3/32, 1/8 inch) of the following: collet, collet body, and 7-inch 2% ceriated tungsten electrode.



**AK4C**  
For W-250 Series, W-280 Super Cool and W-375 Super Cool. Includes

one long back cap, one of each size (#5, #6, #7) alumina nozzle, and one of each size (1/16, 3/32, 1/8 inch) of the following: collet, collet body, and 7-inch 2% ceriated tungsten electrode.

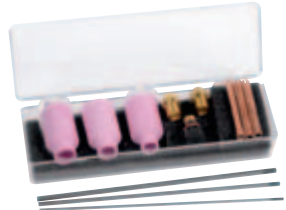

**AK18C**  
For W-400 Super Cool. Includes one short back cap, one of each size (#6, #7, #8) alumina nozzle, one of each size (3/32, 1/8 HD, 5/32 HD)

collet, one of each size (.020-1/8 inch, 1/8-3/16 inch) collet body, and one of each size (3/32, 1/8, 5/32 inch) 7-inch 2% ceriated tungsten electrode.



**AK125C**  
For W-125 Long Micro. Includes one of each size (180°, 45°, 90°, 90° short) glass

nozzle, and one of each size (.040, 1/16 inch) of the following: 180-degree chuck, 45-degree chuck, 90-degree chuck, and 7-inch 2% ceriated tungsten electrode.



**AK150MFC**  
For A-125 Series, A-150 Series and A-150 Modular Series. Allows welding operators to customize their standard A-125 (WP-9) or A-150 (WP-17) TIG torch for their specific

application. Kit converts into 28 different torch styles while using the existing A-125 or A-150 cable. Features collets, collet bodies, nozzles, torch heads, handle and more.



**AK225MFC**  
For W-225 Modular. Includes five additional torch heads, collets, collet bodies, nozzles, handle and more.

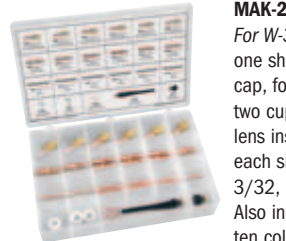

**MAK2S**  
For W-350 Series. Includes one short and one long back cap, four back cap o-rings, two cup gaskets, one gas lens insulator, and one of each size (.040, 1/16, 3/32, 1/8 inch) gas lens. Also includes the following ten collets: (1) .040, (3) 1/16, (3) 3/32, (2) 1/8, (1) 5/32; and eight collet bodies: (1) .040, (2) 1/16, (2) 3/32, (2) 1/8, (1) 5/32.

### Quick Connects



**QRG**  
Allows for quick connection and removal of torch shielding gas hoses.



**QRW**  
Allows for quick connection and removal of torch coolant hoses.

### Cable Covers



**WC-3-10** 3 m (10 ft.)  
**WC-3-22** 6.7 m (22 ft.)  
**WC-3-48** 14.6 m (48 ft.)  
Cable covers protect the welding cables from the day-to-day wear and tear of common welding

environments. Available in 3 m (10 ft.), 6.7 m (22 ft.), and 14.6 m (48 ft.) lengths, these covers can help prevent the frequent replacement of expensive welding cables.

### Remote Controls

See the Accessories section for more information.



East/west rotary-motion fingertip current/contactor controls.



North/south rotary-motion fingertip current/contactor controls.



Foot pedal current/contactor controls.



Miniature hand current/contactor controls.



Momentary- and maintained-contact rocker switch for contactor control.



Momentary-contact switch for contactor controls.



Remote on/off control.





For more detailed information, visit  
MillerWelds.com/insight

# WELDING INTELLIGENCE™



Insight Welding Intelligence™: The Total Welding Data Solution

With an Insight weld monitoring system you can get more done, produce higher-quality welds and control costs.



Complete coverage for any application.



Manufacturing



Automation



Submerged arc

## Choose the Right Welding Intelligence System

		<i>Insight</i> Core™	<i>Insight</i> Centerpoint™	<i>Insight</i> ArcAgent™
<b>For Use With</b>	<b>Factory-Installed</b>	<ul style="list-style-type: none"> <li>Continuum™/Auto-Continuum™ (standard)</li> <li>Deltaweld® (optional)</li> </ul>	<ul style="list-style-type: none"> <li>Continuum™/Auto-Continuum™ (optional)</li> <li>Deltaweld® (optional)</li> </ul>	<ul style="list-style-type: none"> <li>ANY welding power source (old or new)</li> <li>ANY brand</li> <li>ANY welding process</li> </ul>
	<b>Field-Installed/Activated</b>	<ul style="list-style-type: none"> <li>14-pin compliant power source (see MillerWelds.com/insight)</li> </ul>	<ul style="list-style-type: none"> <li>Deltaweld® (optional)</li> </ul>	
<b>Requirements</b>		<ul style="list-style-type: none"> <li>Internet connection (wired/wireless)</li> </ul>	<ul style="list-style-type: none"> <li>PC and Ethernet connection</li> </ul>	<ul style="list-style-type: none"> <li>See Insight ArcAgent literature WI/1.0</li> </ul>
<b>What Capability Do You Need?</b>		<ul style="list-style-type: none"> <li>Productivity monitoring</li> <li>Weld parameter verification</li> <li>Goal setting</li> <li>Analytic tools</li> </ul>	<ul style="list-style-type: none"> <li>Ensure quality welds</li> <li>Reduce missed welds</li> <li>Minimize overwelding/underwelding</li> <li>Electronic work instructions</li> </ul>	<ul style="list-style-type: none"> <li>Universal solution for use with Insight Centerpoint</li> </ul>
<b>Data Storage</b>		<ul style="list-style-type: none"> <li>Cloud based</li> </ul>	<ul style="list-style-type: none"> <li>Local server or PC</li> </ul>	<ul style="list-style-type: none"> <li>See Insight ArcAgent literature WI/1.0</li> </ul>



## Insight Core™

Reports welding productivity from a web-based application to measure and improve your operation.

### Helps you answer

- Who is your most productive operator?
- What is your most productive welder, station, cell?
- Are your quality risks increasing or decreasing?
- What are your true welding costs?



### Software features

#### Measures productivity.

See each welder's arc-on time to set baselines, plan improvements and measure goals.

**Reports.** Easy-to-understand dashboards show trends and develop reports. Compare welders, cells and plants.

#### Easily install and use.

Just connect it to the internet. View secure data on any web-connected device anywhere.

**Analytics tools.** Business analytic tools allowing for weld data analysis based on individual/cell performance as well as overall financial terms.

**Notifications.** Email/text notifications based on your desired frequency and subject.

#### Multiple languages available.

English, German, Spanish, French, Italian, Dutch, Portuguese and Chinese.

### How it works

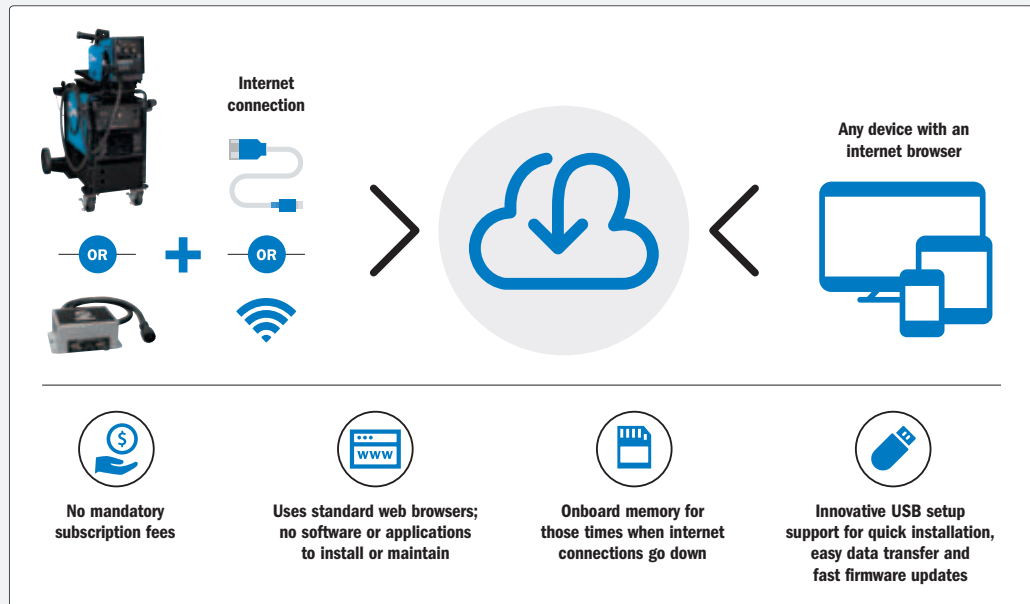

For more information: Email [insight@MillerWelds.com](mailto:insight@MillerWelds.com)

<sup>1</sup> Additional stock numbers are available – visit [MillerWelds.com/insight](http://MillerWelds.com/insight).

<sup>2</sup> SubArc Digital Series also requires Insight Core to SubArc Digital Series Adapter Kit (301295).

Type	Power Sources <sup>1</sup>	Miller 14-Pin Compliant Power Sources
Factory-Installed Insight Core	<b>Deltaweld® 350</b> 907747002 208/230/460 V 907853003 400 V, CE <b>Deltaweld® 500</b> 907785002 208/230/460 V 907786002 575 V 907854003 400 V, CE	<b>Continuum™ 350</b> 907636 230-575 V <b>Continuum™ 500</b> 907640 230-575 V <b>Auto-Continuum™ 350</b> 907656 230-575 V <b>Auto-Continuum™ 500</b> 907657 230-575 V
Field-Installed Insight Core	Insight Module Field-Install Kit for Deltaweld 289303	Requires Insight Core 14-Pin Module 301072 <sup>2</sup> , CE See <a href="http://MillerWelds.com/insight">MillerWelds.com/insight</a> for a list of 14-pin compatible power sources



## Insight Centerpoint™

Real-time welder feedback that provides guidance and control within the weld cell, ensuring consistent quality.

### Helps you

- With productivity/utilization of welding operations
- Share weld data with IIoT solutions
- Present welders with step-by-step work instructions
- Identify the impact of non-welding activities
- Eliminate missing or poor welds

### Version 10

- Designed for ease of use
- Faster start up time
- Drastically shortened learning curve



### Software features

#### Reduce training time.

Part Tracking™ guides welders through the weld sequence in real time, using visualizations of the part.

**Ensure quality welds.** Contain weld defects early and control your weld operation by monitoring every parameter of every weld.

**Reduce costs.** Alert welders if a weld is missed or is outside of acceptable parameters, allowing it to be corrected cost-effectively.

**WorkFlow™.** Gain additional control with documentation through embedded videos, images, audio and other file types.

### How it works

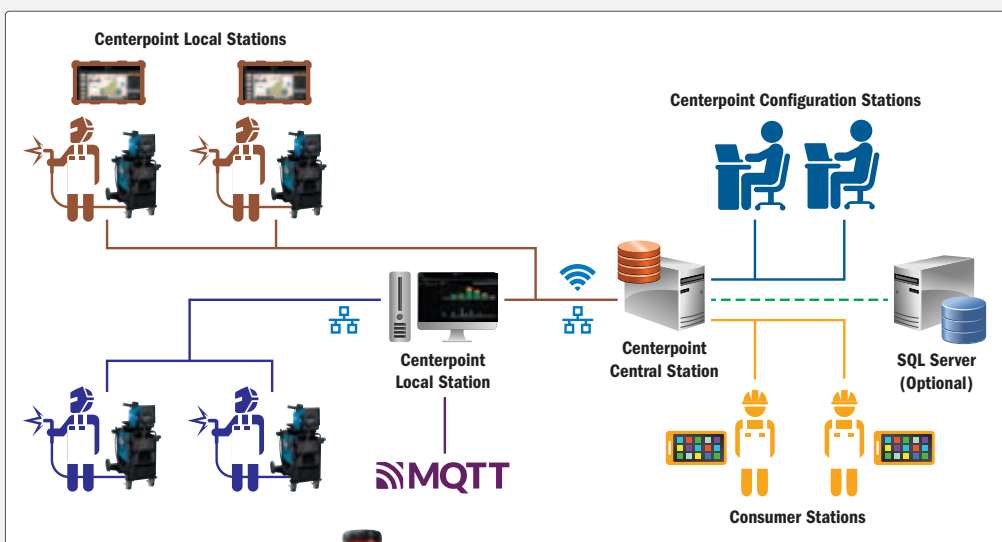

### Universal brand capability

With an ArcAgent™ module, customers can have the power of Insight Centerpoint on any machine from any manufacturer.

For more information: Email [insight@MillerWelds.com](mailto:insight@MillerWelds.com)

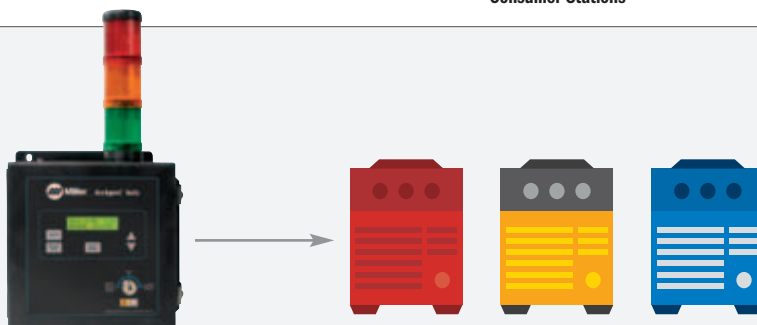

<sup>1</sup> Additional stock numbers are available – visit [MillerWelds.com/insight](http://MillerWelds.com/insight).

Type	Power Sources <sup>1</sup>			Universal Adaptability (works with ALL brands/models of power sources)	Insight Centerpoint Software	Accessories	
Optional Factory-Installed Insight Centerpoint	Deltaweld® 350 907747002 208/230/460 V	Continuum™ 350 907636 230-575 V	Auto-Continuum™ 350 907656 230-575 V	–	301485 Basic device mode	Insight LTD Gun Q4015JS3EML For Deltaweld and Continuum Insight LTD Remote 301383	Field Application Support 195480 Miller field support – contact distributor for details
	Deltaweld® 500 907785002 208/230/460 V 907786002 575 V	Continuum™ 500 907640 230-575 V	Auto-Continuum™ 500 907657 230-575 V				
Field-Installed Insight Centerpoint	Insight Module Field-Install Kit for Deltaweld 289303			Requires ArcAgent Manual or Auto 301345 Manual with Insight torch capability, CE 301346 Auto, CE		M12/RJ45 Ethernet Cables 300734 3 m (9.8 ft.) 300736 10 m (32.8 ft.)	





# ENGINE-DRIVEN

## Fusion 185

See literature ED/2.9

Delivers a smooth, stable arc from either engine power or 120/240-volt utility power, providing a unique combination of versatility and productivity in a lightweight package.



### POWER SHIFT

#### Work anywhere convenience.

PowerShift technology provides weld capabilities using either the Fusion 185 gasoline engine or 120/240-volt utility power. You'll have the confidence of knowing

that you can weld virtually anywhere with just one machine – outdoors with engine or utility power and indoors with utility power. The multi-voltage plug (MVP™) makes it easy to connect the welder to either 120- or 240-volt power.

**Easier to transport.** At only 110 kg (242 lb.), the Fusion 185 is up to 20 kg (45 lb.) lighter than similar machines, so moving it is easier and faster. Less time is spent waiting, and more work can get done.

**Less rework.** Inverter technology delivers a smooth, stable stick arc that's forgiving of variations in arc length and travel speed, so it's easier to produce clean welds that meet specifications – and avoid the time and expense of rework.

Light industrial ● CC DC 1 Phase

#### Process

- Stick (SMAW)

#### Gasoline engine

**Kohler CH440:** 13.4 hp at 3,600 rpm  
One-cylinder, four-cycle, OHV, air-cooled

*Note: Engine is warranted separately by engine manufacturer.*

#### Most popular accessories

- Lifting Eye 195353
- Running Gear 301246
- Twist Lock Adapter Cord 301489
- Protective Cover 301245

Gasoline	Stock Number	Input Power	Welding Mode	Welding Process	Amperage Range	Rated Output at 40°C (104°F)	Amps Input at Rated Output, 50/60 Hz, 1-Phase	Single-Phase Generator Power at 40°C (104°F)	Dimensions	Net Weight
	907781	Engine power	CC/DC	DC stick	30-185	185 A at 26.4 V, 20% duty cycle 110 A at 24.4 V, 100% duty cycle	–	Peak: 6,500 watts (24.75 in.) Continuous: 6,200 watts	H: 629 mm (24.75 in.) W: 510 mm (20.125 in.) D: 794 mm (31.25 in.)	110 kg (242 lb.)
		PowerShift 120 V			30-100	90 A at 23.6 V, 40% duty cycle	22.7	–		
		PowerShift 240 V			30-185	185 A at 26.4 V, 20% duty cycle 110 A at 24.4 V, 100% duty cycle	25.0	–		

## Blue Star® 185

See literature ED/2.5

Reliable outdoor portable power – great for farm, ranch, maintenance, construction and hobbyists.



**Compact and portable.** With a small footprint, the Blue Star uses little truck space. Optional running gear also makes it one-man portable.

**All engine controls are on front panel.**

**Stick and TIG capable.**

**Accu-Rated™ peak generator power** is usable for maximum generator loads such as plasma cutting, Millermatic® MIG welders and motor starting.

**Includes electric start, 120-volt GFCI and 240-volt receptacles, 23.7 L (6.25 gal.) fuel capacity, auto-idle and engine hour meter.**

Light industrial ● CC DC

#### Processes

- Stick (SMAW) ▪ TIG (GTAW)

#### Gasoline engine

**Kohler CH440:** 13.4 hp at 3,600 rpm  
One-cylinder, four-cycle, OHV, air-cooled

*Note: Engine is warranted separately by engine manufacturer.*



#### Most popular accessories

- Lifting Eye 195353
- Running Gear 301246
- Protective Cover 301245



Gasoline	Stock Number	Welding Mode	Welding Process	Amperage Range	Rated Output at 40°C (104°F)	Single-Phase Generator Power at 40°C (104°F)	Dimensions	Net Weight
	907664	CC/DC	DC stick/TIG	60-195	185 A at 25 V, 20% duty cycle 150 A at 25 V, 100% duty cycle	Peak: 6,500 watts Continuous: 6,200 watts	H: 629 mm (24.75 in.) W: 524 mm (20.625 in.) D: 794 mm (31.25 in.)	134 kg (296 lb.)



## Bobcat™/Trailblazer® Gas Model Comparison – Which is Right for You?

	Bobcat: The most popular engine-driven welder		Trailblazer: The best performer in the industry
	<ul style="list-style-type: none"> <li>Cost-effective multiprocess engine-driven welder</li> <li>Dependable power and weld output</li> <li>Independent welder and auxiliary power system</li> <li>Easy to maintain</li> <li>Quietest in its class</li> </ul> 		<ul style="list-style-type: none"> <li>Unbeatable arc performance</li> <li>Independent welder and auxiliary power system</li> <li>Exclusive technologies – advanced Auto-Speed™, Dynamic DIG™ and optional Excel™ power</li> <li>Most fuel efficient and quietest in its class</li> </ul> 
<b>Fuel System</b>	<b>Bobcat 230</b>	<b>Bobcat 265</b>	<b>Trailblazer 330</b>
<b>Fuel Type</b>	Gasoline	Gasoline or LP	Gasoline
<b>Delivery</b>	Carburetor (manual choke)	Carburetor (gas: eChoke™ / LP: manual choke)	Carburetor (eChoke™) or EFI
<b>Weld</b>			
<b>Output</b>	DC only, CC/CV	DC only, CC/CV	DC only, CC/CV
<b>Processes</b>	Stick / MIG / FCAW	Stick / TIG / MIG / FCAW / Gouge	Stick / TIG / MIG / FCAW / Gouge
<b>Amperage Range</b>	20–230 A	20–265 A	20–330 A
<b>Voltage Range</b>	14–25 V	14–28 V	15–40 V
<b>Auxiliary Power</b>			
<b>Peak Watts</b>	11,000 watts	11,000 watts	12,000 watts
<b>Continuous Watts</b>	9,500 watts	9,500 watts	10,500 watts
<b>Excel™ Power (20 A at 120 V, 60 Hz at all engine speeds)</b>	–	–	2,400 watts (option)
<b>Sound Levels</b>			
<b>Maximum / At Idle</b>	73.1 dB / 64 dB	73.1 dB / 64 dB	73.5 dB / 65 dB
<b>Dimensions</b>			
<b>Size (H x W x D)</b>	26.5 x 20.13 x 37.06 in.	26.5 x 20.13 x 37.06 in.	26.5 x 20.13 x 37.06 in.
<b>Weight</b>	376 lb.	382 lb.	400 lb.
<b>Key Features</b>			
<b>Display</b>	Knob	LCD	LCD
<b>Maintenance</b>	Fuel / Hours / Oil	Predictive maintenance	Predictive maintenance
<b>Auto-Set™</b>	–	Yes	Yes
<b>Battery Charge / Crank Assist</b>	–	150 A charge / 300 A crank (option)	150 A charge / 300 A crank (option)
<b>ArcReach®</b>	–	Yes (option)	Yes
<b>Spool Gun</b>	Requires WC adapter	Direct connect	Direct connect

## Bobcat™/Trailblazer®/Big Blue® Air Pak™ Comparison – Which is Right for You?

	Cost-effective engine-driven welder with air compressor and battery charger 	Multiprocess engine-driven welder with air compressor and battery charger 	Heavy-duty, dual-operator multiprocess engine-driven welder with air compressor 
	<b>Bobcat 200 Air Pak</b>	<b>Trailblazer 330 Air Pak</b>	<b>Big Blue 800 Duo Air Pak</b>
<b>Compressed Air</b>	30 cfm, 175 psi	30 cfm, 160 psi	60 cfm, 100 psi
<b>Battery Charge/Crank Assist</b>	12 and 24 volt	12 and 24 volt	–
<b>Auxiliary Power</b>	<b>Single-phase</b>	Peak: 8,000 watts Continuous: 6,500 watts	Peak: 12,000 watts Continuous: 10,500 watts
	<b>Three-phase</b>	–	–
<b>Weld Output Range</b>	30–210 amps DC only, CC/CV	20–330 amps DC only, CC/CV	Single weld mode: 40–800 amps Dual weld mode: 20–400 amps DC only, CC/CV
<b>Fuel Type</b>	Gas / Diesel	Gas	Diesel
<b>Size</b>	29.78 x 20 x 44.61 in. (gas) 29.75 x 20 x 47.25 in. (diesel)	27.02 x 20 x 51.88	46 x 28.5 x 69.5 in.
<b>Weight</b>	514 lb. (gas), 618 lb. (diesel)	587 lb.	2,095 lb.
<b>ArcReach®</b>	–	Yes	Yes



# ENGINE-DRIVEN

## Bobcat™ 200 Air Pak™ See literature ED/4.36

Quiet, fuel-efficient all-in-one that maintains power capabilities in a compact, lightweight footprint and is backed by industry-leading reliability and performance.



Bobcat 200 Air Pak (gas)

Bobcat 200 Air Pak Diesel

**Maximize available payload.** Reduce weight by up to 272 kg (600 lb.) and increase available payload by up to 24 cubic feet by reducing the equipment on the truck.

**Reduce fuel consumption.** Minimize fuel costs by reducing truck engine idle time by as much as 75 percent, or if you have a separate engine-driven compressor by only operating one engine.

**Minimize operating costs.** Potentially save more than \$50,000 over ten years from increased fuel efficiency, decreased maintenance costs and increased asset life.

**Advanced Auto-Speed™ technology** automatically adjusts engine speed to match weld and battery charge demands – reducing fuel consumption, maintenance costs and noise for more efficient jobsites.

**Industrial rotary-screw air compressor.** Easily outperforms and outlasts reciprocating compressors. Many air tools can be powered by the compressor including most 19 mm (3/4 in.) impact wrenches. Immediately supplies 0.85 m<sup>3</sup>/min. (30 cfm) at 175 psi, 100 percent duty cycle, continuous air output.

**210-amp welder.** Maximize downtime and delays by making metal repairs in the field to stay on schedule.

**6,500-watt generator power** to support jobsite tools, lights, and high-demand applications like plasma cutters and TIG welders.

**Battery charge/crank assist.** Provides up to 100 amps at idle to quickly charge 12- and 24-volt batteries. Jobsite equipment with weak batteries can get up to 300 amps of crank assist.

Light industrial **DC**

### Process

- Stick (SMAW) ▪ MIG (GMAW)<sup>1</sup>
- Flux-cored (FCAW)<sup>1</sup> ▪ DC TIG (GTAW)<sup>2</sup>

<sup>1</sup>With voltage-sensing feeder.

<sup>2</sup>Two-piece TIG torch recommended.

### Engines

#### EFI gas: Kohler ECH730

23.5 hp at 3,600 rpm  
Twin-cylinder, four-cycle, overhead valve, industrial, air-cooled

#### EPA Tier 4 Final Diesel: Kubota D722

19 hp at 3,600 rpm  
Three-cylinder, industrial, liquid-cooled

*Note: Engines are warranted separately by engine manufacturer.*

### Most popular accessories

- ArcReach® SuitCase® Feeders
- Spoolmate™ 200 300497
- Spoolmatic® 30A 13083
- Spectrum® 375 X-TREME™
- Multi-Terrain Running Gear 301460
- Full KVA Adapter Cord 300517
- Protective Cover
  - 301475 Gas without running gear
  - 301476 Gas with running gear
  - 301531 Diesel without running gear
  - 301532 Diesel with running gear
- HWY-Mid Frame Trailer 301438
- 25 ft. Battery Charge/Jump Cables with Plug 300422
- Air Compressor Oil Heater 301448
- Air Dryer Kit 301488
- Spool Gun Extension Hose and Cable Kit 132228

	Model/Stock Number	Welding Mode	Welding Process	Amp/Volt Ranges	Rated Weld Output at 40°C (104°F)	Single-Phase Generator Power at 40°C (104°F)	Dimensions	Net Weight
Gasoline	Bobcat 200 Air Pak (907771) Kohler	CC/DC	DC stick/TIG	30-210 A	120 A at 25 V, 100% duty cycle 140 A at 26 V, 60% duty cycle 210 A at 28 V, 20% duty cycle	Peak: 8,000 watts Continuous: 6,500 watts	H: 616 mm (24.25 in.) H: 756 mm (29.78 in.) to top of exhaust W: 508 mm (20 in.) D: 1,133 mm (44.61 in.)	233 kg (514 lb.)
		CV/DC	MIG/FCAW	15-26 V	120 A at 20 V, 100% duty cycle 140 A at 21 V, 60% duty cycle 210 A at 25 V, 20% duty cycle			
Diesel	Bobcat 200 Air Pak Diesel (907760) Kubota	CC/DC	DC stick/TIG	30-210 A	120 A at 25 V, 100% duty cycle 140 A at 26 V, 60% duty cycle 210 A at 28 V, 20% duty cycle	Peak: 8,000 watts Continuous: 6,500 watts	H: 734 mm (28.875 in.) H: 756 mm (29.75 in.) to top of exhaust W: 508 mm (20 in.) D: 1,200 mm (47.25 in.)	280 kg (618 lb.)
		CV/DC	MIG/FCAW	15-26 V	120 A at 20 V, 100% duty cycle 140 A at 21 V, 60% duty cycle 210 A at 25 V, 20% duty cycle			
	Rotocomp Air Compressor	Features			Free Air Delivery	Working Pressure	Duty Cycle	Oil Capacity
		Rotary screw with electric clutch for on/off, oil change intervals 500 hours			0.85 m <sup>3</sup> /min. (30 cfm) at 3,600 rpm	80-175 psig	100%	1.89 L (2 qt.)



# Let Your Welders Weld.™

Game-Changing Control  
Where You Need It Most.

## ArcReach® WELDING SYSTEMS

The more they stop **the more it costs.**



### ARCReach PLUG-IN POWER SOURCES

XMT® 350 FieldPro® Systems  
XMT® 350 FieldPro® Systems with Polarity Reversing  
XMT® 450 CC/CV ArcReach®  
XMT® 650 ArcReach®  
XMT® 650 ArcReach® with Polarity Reversing



### ARCReach STICK/TIG REMOTES

ArcReach® Stick/TIG Remote 301325  
ArcReach® Stick/TIG Remote with Polarity Reversing 300934



### ARCReach WIRE FEEDERS

ArcReach® 16 Feeder  
ArcReach® SuitCase® Feeders  
ArcReach® Smart Feeder



### ARCReach ENGINE-DRIVEN WELDERS

Bobcat™ 265 ArcReach® Model  
Trailblazer® 330  
Big Blue® ArcReach® Models

## ArcReach®

## HEATING SYSTEMS

Preheat faster **so welding schedules stay on time.**



### ARCReach HEATER AIR-COOLED INDUCTION SYSTEM

ArcReach® Heater and Tools

*Note: For product compatibility between ArcReach power sources and accessories, see product literature sheets.*

[MillerWelds.com/arcreach](http://MillerWelds.com/arcreach)



## Bobcat™ Series Gas or LP



**NEW!**

Bobcat 230

**NEW!**

Bobcat 265

**Next-generation Bobcat series –**  
**The most popular engine-driven welder is reliable, powerful and durable. One of the smallest and lightest in its class with more capabilities to take on more jobs – and faster, easier setup too.**



### Easy to use

**Bobcat 230: Single-knob adjustment** for quick and precise setup.  
**Bobcat 265: Digital interface** speeds machine setup and makes it less complicated.



### Separate weld and auxiliary power

**Full auxiliary power at any setting.**



### Exceptional arc performance

**Easy arc starts and less spatter.** Provides DC welding output for greater versatility and quality welds on all types of metals.



### Easier mobility and uses less truck space and payload

**Over 45.36 kg (100 lb.) lighter and 13 percent smaller** than previous models. Bobcat engine-driven welders can easily be moved around and take up less space, leaving more room on your truck for other equipment and tools.



### Easy maintenance

**Bobcat 230: Simple digital display** that tracks your engine hours and alerts you when an oil change is required.

**Bobcat 265: LCD screen** allows for better visibility of routine maintenance items, making it easier to plan downtime.

### Bobcat 265 model additional features



**Auto-Set™** makes weld parameter setup fast, easy and accurate for operators of all skill levels.

**Direct spool gun connection** makes it easy to weld aluminum, expanding the types of jobs you can take on. Adapters are no longer required with the integrated 10-pin connection. Optimized for Spoolmate™ and Spoolmatic® spool guns.



**Remote start/stop** (Bobcat 265 gas only). Take control and eliminate engine noise. Easily turn your Bobcat machine on and off remotely so it only runs when you need it. Get more out of each tank, extend time between maintenance and work without the hassle of walking back to your machine.

**Battery charge/crank assist** (option) ensures that you have reliable DC output when you need it, without carrying a separate charger.

**ArcReach®** (option). Make parameter changes at the weld joint, reducing walks to the machine. Increase arc-on-time, improve your bottom line and improve jobsite safety.



Industrial DC

### Processes

- Stick (SMAW) ▪ MIG (GMAW)<sup>1</sup>
- Flux-cored (FCAW)<sup>1</sup> ▪ DC TIG (GTAW)<sup>2</sup>
- Air carbon arc cutting and gouging (CAC-A)<sup>3</sup> (rated 4.8 mm [3/16 in.] carbons)

<sup>1</sup>With voltage-sensing feeder.

<sup>2</sup>Bobcat 265 models only. Two-piece TIG torch recommended.

<sup>3</sup>Bobcat 265 models only.

### Engines

**Gas: Kohler CH730**

**(with eChoke™ on Bobcat 265)**

23.5 hp at 3,600 rpm

**LP: Kohler CH730**

Liquid withdrawal LP system

21 hp at 3,600 rpm

V-twin-cylinder, four-cycle, overhead valve, industrial, air-cooled

*Note: Engines are warranted separately by engine manufacturer.*

### Most popular accessories

- ArcReach® SuitCase® Feeders
- Spoolmate™ 200 300497 (Bobcat 265 only)
- Spoolmatic® 130831 (Bobcat 265 only)
- ArcReach® Stick/TIG Remote (Bobcat 265 ArcReach model only)
- Spectrum® 625 X-TREME™
- Running Gear
- Protective Cage with Cable Holders
- Hose and LP Tank Mounting Assembly
- Full KVA Adapter Cord 300517
- Protective Cover
- Remote Output Panel Kit 951850
- HWY-Mid Frame Trailer
- Remote Start/Stop Fob Replacement 286385
- Electric Fuel Pump Kit 301741 (gas models only, recommended for operation at altitudes above 1524 m [5,000 ft.])
- 7.6 m (25 ft.) Battery Charge/Jump Cables with Plug 300422 (for use with Bobcat 265 model with battery charge/crank assist)
- Spark Arrestor Kit 300924
- Screen Protector Kit 301742
- Sun Shade 301714

## Bobcat™ 230 (Gas) See literature ED/4.45

Reliable, simple engine-driven welders great for stick and flux-cored welding. Designed for maintenance/repair operations, construction, farm, ranch and auxiliary power use.



## Bobcat™ 230 3 Phase (Gas) See literature ED/4.47

For farm and ranch owners in need of single- and three-phase power. Designed to run 480-volt three-phase pivot irrigation systems and other farm/ranch equipment.



## Bobcat™ 265 (Gas or LP) See literature ED/4.46

**MOST POPULAR!** Reliable, easy to use and more capable engine-driven welders great for stick and flux-cored welding. Designed for maintenance/repair operations, construction, and auxiliary power use.



## Bobcat™ 265X (Gas) See literature EDX/4.46

Reliable, simple engine-driven welders great for stick and flux-cored welding. Designed for maintenance/repair operations, construction, farm, ranch and auxiliary power use.



\*Electric fuel pump recommended for operation at altitudes above 1524 m (5,000 feet).

This feature is on Bobcat 265 model 907826002 and sold as a kit for other Bobcat gas models (see accessories at right).

\*\*For LP model order Hose and LP Tank Mounting Assembly (301710) separately.

	Model	Stock Number*	Welding Mode	Welding Process	Amp/Volt Ranges	Rated Output at 40°C (104°F)	Auxiliary Power at 40°C (104°F)	Dimensions	Net Weight
Gasoline	Bobcat 230	Non-remote start/stop model 907824 Kohler with GFCI	CC/DC	Stick	20-230 A	230 A at 29.2 V, 100% duty cycle	Single-phase Peak: 11,000 watts Continuous: 9,500 watts	H: 673 mm (26.5 in.) H: 792 mm (31.2 in.) to top of exhaust W: 511 mm (20.13 in.) D: 941 mm (37.06 in.)	171 kg (376 lb.)
			CV/DC	MIG/FCAW	14-25 V	230 A at 25.5 V, 100% duty cycle			
	Bobcat 230 3 Phase	Non-remote start/stop model 907842 Kohler with GFCI	CC/DC	Stick	20-230 A	230 A at 29.2 V, 100% duty cycle	Single-phase/three-phase Peak: 10,000 watts Continuous: 8,500 watts	H: 673 mm (26.5 in.) H: 792 mm (31.2 in.) to top of exhaust W: 511 mm (20.13 in.) D: 941 mm (37.06 in.)	175 kg (385 lb.)
			CV/DC	MIG/FCAW	14-25 V	230 A at 25.5 V, 100% duty cycle			
Gas or LP	Bobcat 265	907826 Kohler 907826001 Kohler with GFCI and ArcReach® 907826002 Kohler with GFCI and battery charge/crank assist 907826003 Kohler with GFCI and electric fuel pump	CC/DC	Stick/TIG	20-265 A	265 A at 27 V, 100% duty cycle	Single-phase Peak: 11,000 watts Continuous: 9,500 watts	H: 673 mm (26.5 in.) H: 792 mm (31.2 in.) to top of exhaust W: 511 mm (20.13 in.) D: 941 mm (37.06 in.)	Gas: 173 kg (382 lb.) LP: 166 kg (366 lb.)
			CV/DC	MIG/FCAW	14-30 V	265 A at 27 V, 100% duty cycle			
	Bobcat 265X	907825 Kohler with GFCI							Gas: 171 kg (376 lb.)





# ENGINE-DRIVEN

## Trailblazer® 330 Series Gas or Diesel

See lit. ED/4.76 (Gas) and ED/4.86 (Diesel)



**NEW!**

Trailblazer 330

**NEW!**

Trailblazer 330 Diesel

Optimize your welding operation with new Trailblazer 330 engine-driven welders. They have industry-exclusive benefits to maximize productivity and weld quality, reduce fuel costs, deliver actionable data, and decrease rework and jobsite hazards.

### Easier mobility and uses less truck space and payload

Gas models are over 36.3 kg (80 lb.) lighter and 13 percent smaller than previous model.

### No control cord needed

**ArcReach®** Make parameter changes at the weld joint, reducing walks to the machine. Increase arc-on time, improve your bottom line and improve jobsite safety.

### Unbeatable arc performance

**DYNAMIC DIG™** Provides independent control of the fluidity of the weld puddle (arc control) and the drive of the arc (DIG range). This delivers a tailorable and user-friendly arc to match the application, material, fit-up and welder technique.

### Direct spool gun connection

**Direct hook up** makes it easy to weld aluminum, expanding the types of jobs you can take on. Adapters are no longer required with the integrated 10-pin connection. Optimized for Spoolmate™ and Spoolmatic® spool guns.

### More productive jobsites

**Quieter jobsites** are more productive because work crews can communicate easier, and work can start earlier and end later – even in noise-sensitive areas.

### Auto-Set™

**Predefined weld settings** to increase ease of use and ensure that the job is done right for operators of all skill levels.



### Data visibility

**Productivity screens** make it easier for you to monitor machine use.



### Advanced Auto-Speed™

**Get the welding power you need – plus reduced fuel consumption and lower noise levels** for a more profitable jobsite. Trailblazer-exclusive advanced Auto-Speed responds to weld requirements by automatically adjusting engine speed to a corresponding rpm level so the engine never works harder than necessary. Refueling time and operating costs are reduced, which means more productivity and profitability. Auto-Speed technology – available only from Miller.

### Easy maintenance

**LCD screen** allows for better visibility of routine maintenance items, making it easier to plan downtime.

### Increased performance at high altitude

**Electric fuel pumps are standard on all EFI models** leading to better performance when operating at altitudes of 1,524 m (5,000 feet) or greater.



Heavy industrial ● CC CV DC

## Options to Maximize Your Trailblazer® 330 Performance

### Electronic fuel injection (EFI) (gas models)

**Adding EFI to your Trailblazer engine-driven welder adds multiple benefits.** With EFI, you'll get faster, more-reliable starts in any weather — no choke adjustments needed. Add Excel power to your Trailblazer with EFI for maximum fuel efficiency.

### Excel™ power

**Excel power delivers a full 2,400 watts (20 A) of 120-volt inverter-based, sine wave power at all speeds, including idle.** Unlike competitive machines that provide auxiliary power only at 3,600 rpm (max), with Excel power you can operate jobsite tools like grinders at quiet, fuel-saving speeds.

Refueling time and operating costs are reduced with Excel power, which means more productivity and profitability. Plus everyone on the jobsite gets a better working environment because noise levels are lowered. Excel power — available only from Miller.

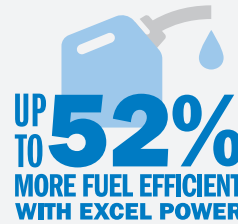

Based on only auxiliary-power-only use for total runtime.

### Battery charge/crank assist

**Reduce downtime with battery charge/crank assist capability.** Designed and recommended for mechanics or anyone responsible for a fleet of trucks or equipment. By using your Trailblazer to charge dead batteries or jump a stubborn engine, you'll keep your crew working and the fleet up and running. Provides up to 150 amps of DC current to quickly charge 12- and 24-volt batteries. Jobsite equipment with weak batteries can get up to 300 amps of crank assist.

Note: Battery charge/jump cables (300422) must be ordered separately.

### Processes

- Stick (SMAW) ▪ MIG (GMAW)<sup>1</sup>
- Flux-cored (FCAW)<sup>1</sup> ▪ DC TIG (GTAW)<sup>2</sup>
- Air carbon arc cutting and gouging (CAC-A) (rated 4.8 mm [3/16 in.] carbons)

<sup>1</sup>With wire feeder.

<sup>2</sup>Two-piece TIG torch recommended.

### Engines

#### Gas: Kohler CH730

23.5 hp at 3,600 rpm

#### EFI gas: Kohler ECH730

23 hp at 3,600 rpm

#### EPA Tier 4 Final Diesel: Kubota D902

24.8 hp at 3,600 rpm

Three-cylinder, industrial, liquid-cooled

Note: Engines are warranted separately by engine manufacturer.

### Most popular accessories

- SuitCase® Feeders
- Spoolmate™ 200 300497
- Spoolmatic® 130831
- ArcReach® Stick/TIG Remote
- Spectrum® 625 X-TREME™
- Running Gear
- Protective Cage with Cable Holders
- Full KVA Adapter Cord
- Protective Cover
- Remote Output Panel Kit 951850
- HWY-Mid Frame Trailer
- Electric Fuel Pump Kit 301741 (gas models only, recommended for operation at altitudes above 1,524 m (5,000 ft.))
- 7.6 m (25 ft.) Battery Charge/Jump Cables with Plug 300422 (for use with Trailblazer models with battery charge/crank assist)
- Spark Arrestor Kit 300924 Gas 043579 Diesel
- Screen Protector Kit 301742
- Sun Shade 301714

\*Electric fuel pump is recommended for gas models operated at altitudes above 1,524 m (5,000 ft.).

This feature is standard on EFI Trailblazers and sold as a kit for other gas models (see accessories at right).

	Model	Stock Number*	Welding Mode	Welding Process	Amp/Volt Ranges	Rated Output at 40°C (104°F)	Single-Phase Auxiliary Power at 40°C (104°F)	Dimensions	Net Weight
Gas	Trailblazer 330	907831 Kohler with GFCI	CC/DC	Stick/TIG	20-330 A	330 A at 30 V, 100% duty cycle	Peak: 12,000 watts Continuous: 10,500 watts  <b>Excel power (optional) 2,400 watts</b> 20 A at 120 V, 60 Hz auxiliary power at idle speed and while welding	H: 673 mm (26.5 in.) H: 792 mm (31.2 in.) to top of exhaust W: 511 mm (20.13 in.) D: 941 mm (37.06 in.)	181 kg (400 lb.)
		907831001 Kohler with Excel power							
		907832 EFI Kohler with GFCI	CV/DC	MIG/FCAW	15-40 V	325 A at 30.25 V, 100% duty cycle			
		907832001 EFI Kohler with Excel power							
		907832003 EFI Kohler with Excel power and battery charge/crank assist							
		907832005 EFI Kohler with Excel power and polarity reversing							
Diesel	Trailblazer 330 Diesel	907849 Kubota with GFCI	CC/DC	Stick/TIG	20-330 A	330 A at 31 V, 100% duty cycle		H: 686 mm (27.02 in.) H: 823 mm (32.41 in.) to top of exhaust W: 523 mm (20.6 in.) D: 1,161 mm (45.72 in.)	277 kg (611 lb.)
		907849001 Kubota with Excel power							
		907849003 Kubota with Excel power and battery charge/crank assist	CV/DC	MIG/FCAW	15-40 V	330 A at 30.5 V, 100% duty cycle			



# ENGINE-DRIVEN

## Trailblazer® 330 Air Pak™ See literature ED/4.79

Powerful all-in-one tool designed for repair and construction with multiprocess weld quality, auxiliary power, air compressor and battery charge/crank assist.

**NEW!**



**Trailblazer 330 benefits and technology.** Equipped with all the standard technology of the Trailblazer 330 (gas) models with the addition of an air compressor.

**Strongest combined auxiliary/compressor power.** Delivers an industry-leading 12,000 watts of peak auxiliary power independent of weld settings.

**Rotary screw air compressor.** Delivers up to 30 cfm and 160 psi with no storage tank and runs many tools at idle speed. Provides 100 percent deliverable air, rated at an industry-high 40°C (104°F). Front panel adjustment and automatic overpressure shutdown with indication. 30,000-hour life expectancy and warranted for three years by Miller.

**Battery charge/crank assist.** Provides up to 150 amps of DC current to quickly charge 12- and 24-volt batteries. Jobsite equipment with weak batteries can get up to 300 amps of crank assist.

*Note: Battery charge/jump cables (300422) must be ordered separately.*

Heavy industrial

### Processes

- DC stick (SMAW) ▪ MIG (GMAW)<sup>1</sup>
- Flux-cored (FCAW)<sup>1</sup> ▪ DC<sup>2</sup> TIG (GTAW)
- Air carbon arc cutting and gouging (CAC-A) (rated 4.8 mm [3/16 in.] carbons, capable 6.4 mm [1/4 in.] carbons)

<sup>1</sup> With wire feeder.

<sup>2</sup> Two-piece TIG torch recommended.

### Gasoline engine

**Kohler CH749:** 27 hp at 3,600 rpm V-twin-cylinder, four-cycle, overhead valve, industrial, air-cooled

*Note: Engine is warranted separately by engine manufacturer.*

### Most popular accessories

- SuitCase® Feeders
- Spoolmate™ 200 300497
- Spoolmatic® 130831
- ArcReach® Stick/TIG Remote
- Spectrum® 625 X-TREME™
- Protective Cover
- 7.6 m (25 ft.) Battery Charge/Jump Cables with Plug 300422

Gasoline

Stock Number	Welding Mode	Welding Process	Amp/Volt Ranges	Rated Weld Output at 40°C (104°F)	Single-Phase Auxiliary Power at 40°C (104°F)	Dimensions	Net Weight
907836 Kohler with GFCI	CC/DC	Stick/TIG	20-330 A	314 A at 32.5 V, 100% duty cycle	Peak: 12,000 watts Continuous: 10,500 watts	H: 686 mm (27.02 in.) H: 787 mm (31 in.) to top of exhaust W: 520 mm (20.46 in.) D: 1,318 mm (51.88 in.)	266 kg (587 lb.)
907836002 Kohler with GFCI and cooler/separator	CV/DC	MIG/FCAW	15-40 V	330 A at 30.5 V, 100% duty cycle			

Rotocomp Air Compressor	Features	Free Air Delivery	Working Pressure	Duty Cycle	Oil Capacity
	Rotary screw with electric clutch for on/off, oil change intervals of 500 hours	0.85 m <sup>3</sup> /min. (30 cfm) at 3,600 rpm	80-160 psig	100%	1.7 L (1.75 qt.)

## Big Blue® 400X Pro See literature ED/5.7

The professional welder's choice — designed with the professional in mind, the Big Blue 400X Pro is the best for ease of use, reliability and fuel economy.



**ArcReach®** Available on select models. Remote control of the power source without a control cord.

**Tailored arc control (DIG)** allows arc characteristics to be changed for specific applications and electrodes. Smooth running 7018 or stiffer, more penetrating 6010.

**Industrial USB port.** Quickly upload the latest software and download machine log files to retrieve in-depth information such as diagnostics and machine statistics.

**10,000 watts of pure generator power.** Plug in an extra Miller® inverter-based power source for an additional welding arc!

**Quiet operation.** Only 71.6 decibels (96 Lwa) under full load. Improves jobsite communication and safety.

**Standard features** include digital meters with SunVision™, automatic idle, adjustable Hot Start™, output contactor control and 120-volt block heater.

Heavy industrial

### Processes

- Stick (SMAW) ▪ MIG (GMAW)
- Flux-cored (FCAW) ▪ DC TIG (GTAW)
- RMD® ▪ Pulsed MIG (GMAW-P)\*
- Air carbon arc cutting and gouging (CAC-A) (rated 4.8 mm [3/16-in.] carbons)

*\*ArcReach models only with ArcReach Smart Feeder.*

### Diesel engines

**Kubota V1505:** 20.2 hp at 1,800 rpm Four-cylinder, industrial, liquid-cooled

**CAT C1.5:** 21.7 hp at 1,800 rpm Three-cylinder, liquid-cooled

*Note: Engines are warranted separately by engine manufacturer.*

### Most popular accessories

- ArcReach® SuitCase® Feeders
- ArcReach® Smart Feeder\*\*
- ArcReach® Stick/TIG Remote\*\*
- Dynasty® 210 Series
- Protective Cover 195301

*\*\*For ArcReach models only.*

Diesel

Stock Number	Welding Mode	Process	Amp/Volt Ranges	Rated Output at 40°C (104°F)	Single-Phase Generator Power at 40°C (104°F)	Dimensions	Net Weight
(907732010) Kubota, CE	CC/DC	Stick/TIG	20-400 A	300 A at 32 V, 100% duty cycle 350 A at 27 V, 100% duty cycle	Peak: 12,000 watts Continuous: 10,000 watts	H: 813 mm (32 in.) W: 667 mm (26.25 in.) D: 1,422 mm (56 in.)	Kubota 456 kg (1,003 lb.) CAT 500 kg (1,100 lb.)
(907732011) Kubota w/ArcReach, CE							
(90774002) CAT Turbo w/ArcReach	CV/DC	MIG/FCAW	14-40 V	400 A at 24 V, 100% duty cycle			







## Big Blue® 500X Pro

See literature ED/11.0

Clean, quiet, multiprocess machines designed to give welders the output they need for heavy-duty applications on construction and fabrication sites.



### ArcReach®

Remote control of the power source without a control cord.



**Arc control** is beneficial when welding with stick and solid wires for easier fine-tuning of tough-to-weld materials and out-of-position applications.

**Industrial USB port.** Quickly upload the latest software and download machine log files to retrieve in-depth information such as diagnostics and machine statistics.

**Low OCV stick (VRD)** for improved operator safety without compromising arc starts.

**Auto Remote Sense™ (ARS)** detects if a remote control is plugged into the 14-pin receptacle and eliminates confusion of a remote/panel switch.

**15,000 watts of pure generator power.** Plug in an extra Miller® inverter-based power source for an additional welding arc!

**Standard features** include digital meters with SunVision™, adjustable Hot Start™ output contactor control, automatic idle, thermal overload protection and 120-volt block heater.

Heavy industrial **CC CV DC**

#### Processes

- Stick (SMAW) • MIG (GMAW)
- Flux-cored (FCAW) • DC TIG (GTAW)
- RMD®\* • Pulsed MIG (GMAW-P)\*
- Air carbon arc cutting and gouging (CAC-A) (rated 8 mm carbons)

\*ArcReach models only with ArcReach Smart Feeder.

#### Diesel engine Deutz D2011L03i

3-cylinder, industrial, air/oil-cooled

Note: Engines are warranted separately by engine manufacturer.

#### Most popular accessories

- ArcReach® SuitCase® 8/12
- ArcReach® Smart Feeder\*\*
- ArcReach® Stick/TIG Remote\*\*
- Dynasty 210® Series
- Full KVA Adapter Cord
- Full KVA Plug Kit
- Protective Cover 301495 301113
- HWY-225 Trailer 301338
- Wireless Remote Hand Control/Wireless Antenna Kit 300430 / 300749
- Spark Arrestor Kit 195012

\*\*For ArcReach models only.

Diesel	Stock Number	Welding Mode	Process	Amp/Volt Ranges	Rated Output at 40°C (104°F)	Generator Power at 40°C (104°F)	Dimensions	Net Weight
	(907788) Deutz with ArcReach	CC/DC	DC stick/TIG	20-500 A				
		CV/DC	MIG/FCAW	14-50 V				



# ENGINE-DRIVEN

## Big Blue® 500X CC and 600X CC

See literature ED/10.11

Designed for fleet owners that demand the ultimate in reliability and performance. Built with reliable, heavy-duty industrial components for operation in remote locations, without downtime.



Big Blue 600X CC shown.

### Meter maintenance displays:

- Hour meter function and Oil change interval
- High coolant temperature and low oil pressure shutdowns
- Low fuel shutdown — engine shuts down before system runs out of fuel, making restarts easy

**Enclosed robust case design** protects internal components from impact and allows air flow to cool and prolong the life of the engine. Also reduces sound levels.

**Hot Start™** provides positive stick electrode starts making it easy to start all types of electrodes and it also works great for bead tie-ins.

**Arc-Drive™** makes welding easy. Automatically enhances stick welding, especially on pipe, by focusing the arc and preventing the electrode from going out.

**5,500-watt peak AC power** independent of weld settings means no interaction between tools and welding arc.

**Quick and easy maintenance** with single-side access to oil level check, oil fill, oil filter, fuel filter and air cleaner.

### Heavy Industrial ● CC DC

#### Processes

- (SMAW)
- TIG (GTAW)
- Air Carbon Arc Cutting and Gouging (CAC-A) (500X: rated 8 mm [5/16 in.] carbons); (600X: rated 9.5 mm [3/8 in.] carbons)

#### Diesel engines

##### 500X – Deutz D2011L03i

3-cylinder, industrial, air/oil-cooled

##### 500X – Perkins 404D-22

4-cylinder, industrial, liquid-cooled

##### 600X – Deutz D2011L04i

4-cylinder, industrial, air/oil-cooled

*Note: Engines are warranted separately by engine manufacturer.*

#### Most popular accessories

- Engine Filter Kits
  - Deutz 2011 246988
  - Deutz 912 246989
  - Perkins 404 246985
- Cold Weather Starting Aids available for all units
- Weld Meters 195131
- Battery Voltmeter 195454
- Spark Arrestor Kit 195012
- Protective Cover 194683
- RHC-3GD34A Remote Hand Control 041122

Model	Stock Number	Description	Process	Amp/Volt Ranges	Rated Output at 40°C (104°F)	Generator Output Rated at 40°C (104°F)	Shipping Weight
Big Blue 500 X CC	(907185) (907185001) with auto idle, V-A meters and battery meter	Deutz D2011L03i	DC, Stick/TIG	55-500 A	400 A at 36 V (14.4 kW), 100% duty cycle 450 A at 38 V (17.1 kW), 60% duty cycle 500 A at 30 V (15 kW), 40% duty cycle	Peak: 5500 watts Continuous: 4000 watts, 34/17 A, 120/240 VAC, 50/60 Hz while welding	907185: 728 kg (1604 lb.)
Big Blue 600 X CC	(907193) with auto idle, V-A meters and battery meter	Deutz D2011L04i		65-600 A	500 A at 40 V (20 kW), 100% duty cycle 550 A at 34 V (18.7 kW), 60% duty cycle 600 A at 30 V (18 kW), 40% duty cycle		Deutz: 769 kg (1695 lb.)



## Big Blue® 450 Duo CST™ See literature ED/5.5

Durable dual-operator welder/generator delivers proven CST stick/TIG performance with two superior arcs in one compact package, for maximum productivity and efficiency.



**IMPROVED!**

Steel panel of vandalism lockout kit is flipped up on image shown.

**Two separate outputs with Tweco®-style receptacles** deliver up to 280 amps of output per operator.

**Quiet operation.** At 71 decibels (96 Lwa) under full load, it's quieter than most single-operator models. Improves jobsite communication and safety.

**Vandalism lockout kit.** Lockable hinged steel panel protects front control panels and ignition switch.

**Simple-to-operate process select** with optimized arc control settings for E6010 and E7018 electrodes for superior SMAW performance.

**Lift-Arc™** start for TIG starts without the use of high frequency.

**Remote amperage control** permits the use of standard and wireless amperage control devices.

**Increased efficiency.** More arcs and better fuel economy equal increased profits for your business. Estimated savings are up to 34 percent with a dual-operator unit versus two single-operator units.

Heavy industrial ● **CC DC**

### Processes

- Stick (SMAW) • DC TIG (GTAW)
- Air carbon arc cutting and gouging (CAC-A) (rated 4.8 mm [3/16 in.] carbons)

### Diesel engine

#### EPA Tier 4 Final

**Mitsubishi S4L2:** 24.7 hp at 1,800 rpm

Four-cylinder, industrial, liquid-cooled

*Note: Engine is warranted separately by engine manufacturer.*

### Most popular accessories

- Full KVA Adapter Cord 300517
- Single-Phase Full KVA Plug Kit 119172
- Protective Cover 195301
- HWY-Mid Frame Trailer 301438
- Wireless Remote Hand Control 301582

Diesel	Stock Number	Process	Output Mode	Amperage Range	Rated Output at 50°C (122°F)	Single-Phase Auxiliary Power at 50°C (122°F)	Dimensions	Net Weight
	907866 Mitsubishi	DC stick/TIG	Separate (dual outputs)	5-225 (each side) 5-280 (one side only)	175 A at 27 V, 100% duty cycle	Peak: 10,500 watts Continuous: 8,900 watts	H: 813 mm (32 in.) H: 876 mm (37 in.) to top of exhaust W: 667 mm (26.25 in.) D: 1,422 mm (56 in.)	483 kg (1,064 lb.)
			Paralleled (combined)	10-450	350 A at 27 V, 100% duty cycle			

## Big Blue® 700X Duo Pro See literature ED/5.6

A complete multiprocess and multioperator welder/generator in one rugged package. Up to 400 amps of output per operator can be paralleled with a single switch to provide up to 800 amps of power.



WIRELESS  
REMOTE  
COMPATIBLE

### ArcReach®

Remote control of the power source without a control cord.

**Two independent pipe quality arcs** in one compact package.

**Multiprocess CC/CV capability** provides independent operator controls and the best Stick, MIG, Flux-cored and TIG performance available with no interaction.

**Easy arc starts and better arc control** for best in class performance.

**Independent remote control connections** allow the use of standard and wireless volt/amperage control devices for each operator.

**Quiet operation.** At just 68 dB at idle or 76 dB at 7 m (23 ft.) at full load, it's quieter than many single-operator models, improving jobsite communication and safety.

**Smaller, lighter, quieter, and smoother running** than competitive models with comparable output.

**Standard features** include oil pan heater, intake manifold heater, output paralleling switch and automatic idle.

**Smart feeder compatible.** Advanced RMD® and pulsed MIG processes are now available in an engine-driven welder/generator. Discover increased productivity, quality, and improved efficiency in field welding.

Heavy industrial ● **CC CV DC**

### Processes

- Stick (SMAW) • MIG (GMAW)
- Flux-cored (FCAW) • TIG (GTAW)
- Air Carbon Arc Cutting and Gouging (CAC-A) (rated 9.5 mm [3/8 in.] carbons)
- RMD • Pulsed MIG (GMAW-P) with ArcReach Smart Feeder

### Diesel engine Deutz D2011L04i:

48.6 HP at 1800 RPM

Four-cylinder, industrial, air/oil-cooled

*Note: Engine is warranted separately by engine manufacturer.*

### Most popular accessories

- ArcReach® SuitCase®  
8: 301457 / 12: 301456 / 12RC: 301121
- ArcReach® Smart Feeder 300935
- ArcReach® Stick/TIG Remote 301325
- Wireless Remote Hand Control/Wireless Antenna Kit 300430/300749
- Spectrum® 875
- Adapter Cord, Full KVA 300517
- Full KVA Plug Kit: 1-Phase 119172  
3-Phase 254140
- Protective Cover 194683
- HWY-225 Trailer 301338
- Engine Filter Kit 246988

Diesel	Stock Number	Welding Mode/Process	Output Mode	Amp Range	Rated Output at 40°C (104°F)	Generator Output Rated at 40°C (104°F)	Dimensions	Net Weight
	(907762) Deutz with ArcReach and Parallel Switch	CC/DC (Stick/TIG)	Separate (dual outputs)	20-400 A (each side)	300 A at 28 VDC, 100% duty cycle 400 A at 36 VDC, 40% duty cycle	Three-Phase: 20,000 watts continuous or Single-Phase: 12,000 watts continuous 380/400V Three-Phase Auxiliary Power	H: 1,092 mm (43 in.) W: 724 mm (28.5 in.) D: 1,654 mm (65.125 in.)	784 kg (1,729 lb.)
			Paralleled (combined)	40-800 A	500 A at 34 VDC, 100% duty cycle 700 A at 24 VDC, 60% duty cycle			
		CV/DC (MIG/FCAW)	Separate (dual outputs)	14-50 V (each side)	300 A at 28 VDC, 100% duty cycle 400 A at 34 VDC, 40% duty cycle			
Paralleled (combined)			14-50 V	500 A at 34 VDC, 100% duty cycle 700 A at 24 VDC, 60% duty cycle				





# ENGINE-DRIVEN

## Big Blue® 800X Duo Air Pak™ See literature ED/13.0

The most powerful diesel welder/generator in the industry. Robust output for welding and power generation, and ideal for dual-operator applications on labor intensive jobsites, or jobsites with limited space.



### ArcReach®

Remote control of the power source without a control cord.



**Multi-arc welding.** One dependable engine – two independent arcs with up to 400 amps each. Or plug in additional inverters for a true multioperator work platform! Example: Two additional XMT machines equals four operators, up to 200 amps each. Premium quality arcs allow operators to work independently with no arc interaction. Multioperator welding has never been easier or more versatile.

**Increased efficiency.** More arcs and better fuel economy equal increased profits for your business. Estimated savings are 34 percent with a dual-operator unit versus two single-operator units.

**Simple paralleling switch** makes switching from a single operator to dual operators a breeze. Weld up to 400 amps per side when set up in dual-operator mode, or up to 800 amps in single-operator mode.

**Electronic engine display** simultaneously displays fuel level, engine hours, coolant temperature, oil pressure, battery volts and engine rpm. Also tracks oil change intervals and displays engine diagnostics for easier servicing. Air Pak model adds air pressure and compressor hours displays.

**Arc control** is beneficial when welding with stick and solid wires for easier fine-tuning of tough-to-weld materials and out-of-position applications.

**Industrial USB port.** Quickly upload the latest software and download machine log files to retrieve in-depth information such as diagnostics and machine statistics.

**20,000 watts of pure generator power.** Plug in an extra Miller® inverter-based power source for an additional welding arc!

**Standard features** include digital meters with SunVision™ automatic idle, 120-volt block heater and vandalism lockout (protects control panel and receptacles, see photo at right).



**Ingersoll Rand ultra-reliable industrial rotary screw compressor.** 30,000-hour life expectancy. Independent on/off control for applications not requiring compressed air— allows greater fuel savings and longer compressor service intervals.

### Heavy Industrial

#### Processes

- Stick (SMAW) ▪ MIG (GMAW)
- Flux-cored (FCAW) ▪ DC TIG (GTAW)
- RMD\*\* ▪ Pulsed MIG (GMAW-P)\*
- Air carbon arc cutting and gouging (CAC-A) (rated 12.7 mm [1/2-in.] carbons)
- Stud (12.7 mm [1/2 in.]

\*With ArcReach Smart Feeder.

#### Diesel engine

##### Deutz TD2011L04i

63.4 hp at 1,800 rpm

Turbo-charged, four-cylinder, industrial, air/oil-cooled

Note: Engines are warranted separately by engine manufacturer.

#### Most popular accessories

- ArcReach® SuitCase®  
8: 301457 / 12: 301456 /  
12RC: 301121
- ArcReach® Smart Feeder 300935
- ArcReach® Stick/TIG Remote 301325
- Dynasty 210® Series
- Full KVA Adapter Cord 300517
- Full KVA Plug Kit  
119172 Single-phase  
254140 Three-phase
- Protective Cover 301113
- HWY-225 Trailer 301338
- Four-Wheel Off-Road Trailer 042801
- Wireless Remote Hand Control /  
Wireless Antenna Kit  
300430/300749



#### Desiccant Air Dry System (Air Pak model only)

- 195117 Side mount
- 195117001 Rear mount
- Eliminates moisture in the air stream and prevents air line freeze-ups in cold climates.
- Spark Arrestor Kit 195012

\*Welder truck specific models available – visit MillerWelds.com or your distributor.

Diesel	Stock Number*	Welding Mode/Process	Output Mode	Amp/Volt Ranges	Rated Output at 100% Duty Cycle at 40°C (104°F)	Generator Power at 40°C (104°F)	Dimensions	Net Weight
	(907763) Deutz with ArcReach	CC/DC (Stick/TIG)	Separate (dual outputs)	20–400 A	400 A at 36 V (each side)	Three-phase Peak: 27,000 watts Continuous: 20,000 watts 380/400V Three-phase auxiliary power	H: 1,168 mm (46 in.) W: 724 mm (28.5 in.) D: 1,765 mm (69.5 in.)	968 kg (2,095 lb.)
		CV/DC (MIG/FCAW)	Paralleled (combined)	40–800 A	700 A at 44 V, 800 A at 38 V			
			Separate (dual outputs)	14–50 V	400 A at 34 V (each side)	Single-phase Peak: 15,000 watts Continuous: 12,000 watts		
			Paralleled (combined)	14–50 V	750 A at 40 V, 800 A at 38 V			
	Ingersoll Rand CE55 G1 Air Compressor	Features		Free Air Delivery		Working Pressure Constant	Duty Cycle	Oil Capacity
		Rotary screw with electric clutch for on/off, oil change intervals of 500 hours, life expectancy of 30,000 hours		Idle: 1.13 m <sup>3</sup> /min (40 cfm) Weld: 1.70 m <sup>3</sup> /min (60 cfm)		100 psig (7 bar)	100%	3.79 L (4 qt.)



Miller offers an array of versatile submerged arc components, including power sources, controls, wire drives, torches, tractors and a variety of other accessories.

## SubArc Digital Series See literature AD/7.3

The SubArc Digital Series of power sources, interface controls and accessories include digital control and communication electronics designed to improve weld performance and simplify the integration of the equipment in more advanced applications.



**Heavy Industrial** ● SubArc DC Series is DC only.

- Processes**
- Submerged arc (SAW)
  - Electroslag (ESW)
  - Air carbon arc cutting and gouging (CAC-A)
- Most popular accessories**
- 14-pin Insight Core™ Module 301072  
Requires Insight Core to SubArc Digital Series Adapter Kit (301295).
  - ArcAgent™ Auto 301346
  - 4.6 m (15 ft.) SubArc Parallel Cable 260775015
  - 4.6 m (15 ft.) SubArc Tandem Cable 260878015

**Two DC power source models and one AC/DC power source model.** Power sources have sufficient power capacity to cover applications from traditional DC single-arc to multi-wire tandem welding. In the case of electroslag welding or other high-current demand, two or more power sources can easily be paralleled (both DC and AC/DC machines).

**Low-voltage accessory operation and improved environmental protection.** The Digital Series accessories are powered with 24 VAC control voltage from the power source. All power sources, interface controls and wire drives are IP23 rated providing a high level of protection for harsh environments.

**Easy to integrate.** Our SubArc power sources are easy to integrate by using a standard Modbus® connection.

**All power sources also feature thermal overload protection, line voltage compensation and Fan-On-Demand.™**

*\*While idling.*

Model/Stock Number	Amperage Range (CC Mode)	Voltage Range (Sub Arc Mode)	Rated Output	IP Rating	Amps Input at Rated Output, 50 Hz					Max Open-Circuit Voltage	Dimensions (Includes lift eye, but not strain relief)	Net Weight
					380 V	400 V	440 V	KVA	KW			
<b>SubArc DC 650 Digital (907622)</b> 230/460/575 V, 60 Hz <b>SubArc DC 800 Digital (907623)</b> 380/400/440 V, 50 Hz, CE	50-815 A	20-44 V	650 A at 44 V, 100% duty cycle	IP23	95 1.9*	90 1.8*	83 1.6*	50 1.52*	34.8 0.76*	75 Vpk	H: 762 mm (30 in.) W: 584 mm (23 in.) D: 965 mm (38 in.)	269 kg (593 lb.)
<b>SubArc DC 1000 Digital (907624)</b> 230/460/575 V, 60 Hz <b>SubArc DC 1250 Digital (907625)</b> 380/400/440 V, 50 Hz, CE	100-1,250 A	20-44 V	1,000 A at 44 V, 100% duty cycle	IP23	135 5.2*	128 5.0*	117 4.5*	73 3.2*	53 0.5*	68 Vpk		309 kg (682 lb.)
<b>SubArc AC/DC 1000 Digital (907620)</b> 460 V, 60 Hz <b>SubArc AC/DC 1250 Digital (907621)</b> 380/400 V, 50 Hz, CE	300-1,250 A	20-44 V	1,000 A at 44 V, 100% duty cycle	IP23	179 3.0*	176 3.0*	—	122 2.37*	67 0.95*	93 Vpk	H: 1,092 mm (43 in.) W: 711 mm (28 in.) D: 1,219 mm (48 in.)	538 kg (1,187 lb.)



# SUBMERGED ARC

## SubArc Interface Control

See literature AD/7.3



**Easier setup and operation.** The SubArc Digital Series Interface controls recognize the power source and wire drive connected, and automatically configure the system for proper operation.

**Internal terminal strip** is able to integrate with positioners, sidebeams, turning rolls and other peripheral equipment.

### Most popular accessories

- SubArc Control Cables
  - 260622030 9 m (30 ft.)
  - 260622050 15 m (50 ft.)
  - 260622060 18.3 m (60 ft.)
  - 260622080 24.4 m (80 ft.)
  - 260622100 30.5 m (100 ft.)
  - 260622120 36.6 m (120 ft.)
  - 260622200 61.0 m (200 ft.)

Model/Stock Number	Input Power from Welding Power Source	Welding Power Source Type	Dimensions	Net Weight
SubArc Interface Digital (300936), CE	24 VAC, 1-phase, 25 A, 50/60 Hz	Constant voltage (CV), AC or DC, with remote contactor and output control capabilities	H: 292 mm (11.5 in.) W: 305 mm (12 in.) D: 178 mm (7 in.)	7.2 kg (15.8 lb.)

## SubArc Remote Operator Interface

See literature AD/7.3



Motor Control Digital



Remote Pendant Digital

**Point-of-use installation.** Remote Pendant can be handheld or secured at point of use to improve operation.

**Remote installation.** Motor Control can be remotely installed, resulting in reduced cables at the operator workstation.

**Side handles** on Remote Pendant provides option for handheld operation with full functionality of a traditional SubArc Interface.

### Most popular accessories

- Continuum Control/Motor Cables
  - 263368015 4.6 m (15 ft.)
  - 263368025 7.6 m (25 ft.)
  - 263368050 15 m (50 ft.)
- SubArc Control Cables
  - 260622030 9 m (30 ft.)
  - 260622050 15 m (50 ft.)
  - 260622080 24.4 m (80 ft.)

Model/Stock Number	Input Power from Welding Power Source	Welding Power Source Type	Dimensions	Net Weight
SubArc Motor Control Digital (301425), CE (requires SubArc Remote Pendant Digital below and Continuum control/motor cable)	24 VAC, 1-phase, 25 A, 50/60 Hz	Constant voltage (CV), AC or DC, with remote contactor and output control capabilities	H: 292 mm (11.5 in.) W: 305 mm (12 in.) D: 178 mm (7 in.)	5.9 kg (13 lb.)
SubArc Remote Pendant Digital (301424), CE (requires SubArc Motor Control Digital above and Continuum control/motor cable)			H: 279 mm (11 in.) W: 270 mm (10.63 in.) D: 80 mm (3.125 in.)	1.4 kg (3 lb.)

## SubArc Wire Drive 400 Digital Low Voltage

See literature AD/7.3



**SubArc Wire Drive 400 Digital Low Voltage** is a standard-speed, right-angle wire drive assembly.

### Most popular accessories

- Motor Extension Cables
  - 254232005 1.5 m (5 ft.)
  - 254232010 3 m (10 ft.)
  - 254232025 7.6 m (25 ft.)
  - 254232065 19.8 m (65 ft.)
- Single-Wire Straightener 199733
- Twin-Wire Straighteners (for twin-wire torches only)
  - 301160 Single adjustment
  - 301162 Double/separate adjustment
- Drive Rolls
- Manual Slide

Model	Stock Number	Input Power	Input Power Cord	Rating	Wire Feed Speed	Wire Diameter Capacity	Net Weight
SubArc Wire Drive 400 Digital Low Voltage	(300938) Standard speed, CE	38 VDC	1.2 m (4 ft.)	1/5 hp, 85 rpm	0.8–10.2 mpm (30–400 ipm)	2.4–4.8 mm (3/32–3/16 in.)	11.8 kg (26 lb.)





## SubArc Torches

See literature AD/7.3

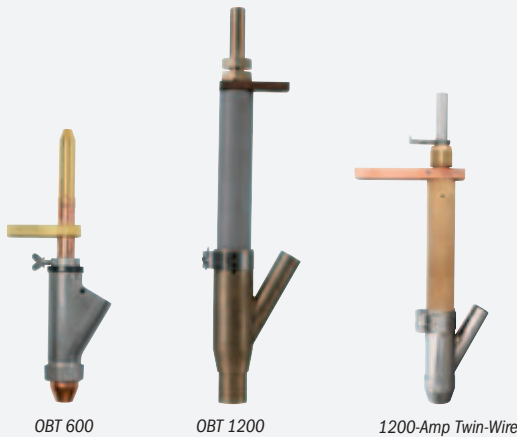

OBT 600

OBT 1200

1200-Amp Twin-Wire

**OBT 600** is a 600-amp, 100 percent duty cycle torch with concentric flux flow nozzle. Can be used with 1.6–4.0 mm (1/16–5/32 in.) wire.

**OBT 1200** is a 1,200-amp, 100 percent duty cycle torch with concentric flux flow nozzle. Can be used with 1.6–4.8 mm (1/16–3/16 in.) wire. OBT 1200 features a replaceable breakaway adapter end to prevent costly damage should torch run into an obstruction.

**1200-Amp Twin-Wire Torch (long)** is a 1,200-amp, 100 percent duty cycle torch. For use with 1.2–2.4 mm (3/64–3/32 in.) wire.

### Most popular accessories

- OBT 600 Torch Body Extensions  
043967 25.4 mm (1 in.)  
043969 50.8 mm (2 in.)  
043973 101.6 mm (4 in.)  
043975 152.4 mm (6 in.)
- OBT 1200 Torch Body Extension 043981
- Contact Tips

Model/Stock Number	Rated Output	Wire Diameter Capacity	Single/Twin	Torch Body Length
OBT 600 (043923)	600 A at 100% duty cycle	1.6-4.0 mm (1/16-5/32 in.)	Single	260.4 mm (10.25 in.)
OBT 1200 (043900)	1,200 A at 100% duty cycle	1.6-4.8 mm (1/16-3/16 in.)	Single	438.2 mm (17.25 in.)
1200-Amp Twin-Wire Torch (301144) Long	1,200 A at 100% duty cycle	1.2-2.4 mm (3/64-3/32 in.)	Twin	431 mm (16.97 in.)

## SubArc 3-Wheel Tractor

See literature AD/7.7



**Easy-to-use foot- or hand-operated clutch** allows for easy engagement of tractor drive and disengagement to move tractor into position.

**Flexible mast configuration** allows torch to be positioned in multiple weld zones and adapts to your weld application.

**SubArc Tractor Interface Digital** provides easy-to-operate single control for power source and tractor operation.

**Regulated travel speed** ensures your actual and set travel speeds are consistent, improving weld quality.

**Locking front wheel** can be set in place to desired travel path.

**Easily accommodates a 27 kg (60 lb.) wire reel** for fewer time-consuming wire changeovers.

**Low-voltage operation and improved environmental protection.** The digital series accessories are powered with 24 VAC control voltage from the power source. All power sources, interface controls and wire drives are IP23 rated providing a high level of protection for harsh environments.

### Required system components (sold separately)

- SubArc 3-Wheel Tractor 301446
- SubArc Tractor Interface Digital 301423
- SubArc Wire Drive 400 Digital Low Voltage 300938002
- 4.5 kg (10 lb.) capacity flux hopper with manual valve 301445
- 27 kg (60 lb.) wire reel 108008
- OBT 600 torch 043923
- Wire straightener 199733

### Required power source

- SubArc Digital Series

### Most popular accessories

- SubArc Control Cables
- Contact Tips
- Drive Rolls

Model/Stock Number	Input Power from Welding Power Source	Wire Feed Speed	Wire Diameter Capacity	Gun Positioning Slides	Drive Motor	Travel Speed	Dimensions	Net Weight
Digital 3-Wheel Tractor (301466) Subarc Tractor Interface (301423) Subarc Flux Hopper Manual (301445)	24 VAC, 1-phase, 50/60 Hz, 25 A	0.8-10.2 mpm (30-400 ipm)	1.6-4.0 mm (1/16-5/32 in.)	88.9 mm (3.5 in.)	38 VDC	0.13-1.75 m/min. (5-70 ipm)	H: 914 mm (36 in.) W: 1,149 mm (43.25 in.) D: 803 mm (31.63 in.)	54.4 kg (120 lb.) without flux or wire



# SUBMERGED ARC

## SubArc Flux Hopper

See literature AD/7.3



**Improved flux delivery system.** Our SubArc Flux Hopper Digital Low Voltage utilizes a flux valve mechanism that assures continuous delivery of flux to the arc.

**Sight glass** allows the weld operator to visually monitor the remaining flux in the hopper.

**Versatile opening** is sized to allow hook-up of any flux-hopper-mounted recovery system.

**Includes slag screen** to capture fused slag particles from entering the flux hopper.

### Most popular accessories

- Flux Hopper Extension Cables  
260623010 3 m (10 ft.)  
260623025 7.6 m (25 ft.)  
260623065 19.8 m (65 ft.)

Stock Number	Input Power	Input Power Cord	Flux Capacity	Net Weight
SubArc Flux Hopper Digital Low Voltage (300942)	12 VDC (PWM signal from SubArc Interface)	3.3 m (11 ft.)	11 kg (25 lb.)	5 kg (11 lb.)

## SubArc Portable Welding System

See literature AD/7.6



SubArc DC 650  
Digital portable  
system shown.

**Self-contained system** for pressure vessel, pipe and general welding applications. Houses a power source, column and boom on a mobile platform.

**Built-in fork pockets and caster wheels** allow welding system to be brought to the joint.

**Easy positioning of the weld head** through use of integrated motorized column, manual telescoping boom, slide and 360-degree column rotation.

**Motorized column with pendant control and manual telescoping boom** provides 1,117 mm (44 inches) of vertical travel and 787 mm (31 inches) of horizontal travel respectively.

**Manual slide** provides 200 mm (7.87 inches) of fine vertical and horizontal torch adjustment.

### Systems include

- Portable column and boom
- SubArc Digital power source
- SubArc Interface Digital and control cable
- SubArc Wire Drive 400 Digital Low Voltage
- 11.3 kg (25 lb.) capacity flux hopper with valve
- 27 kg (60 lb.) wire reel and support assembly
- OBT 600 torch (650 system) or OBT 1200 torch (1000 system)
- Wire straightener
- Manual slide

### Most popular accessories

- 14-pin Insight Core™ Module 301072  
Requires Insight Core to SubArc Digital Series Adapter Kit (301295)
- Insight ArcAgent™ Auto 301346
- Contact Tips
- Drive Rolls

Stock Number	Supply Voltage	Column Stroke	Column Travel	Boom Stroke	Boom Travel	Base Rotation	Overall Height
(301133004) Column and Boom only with International packing	120 V, 1-phase, 60 Hz	1,117 mm (44 in.)	Constant speed	787 mm (31 in.)	Manual	360°	2,590 mm (102 in.)



## ProHeat™ Induction Heating

Induction heating is a simple and cost-effective heating process that can deliver fast and consistent heat. Applications that would typically require hours to heat can be done in minutes.

- Welding fabrication and construction
- Preheating of welds
- Post-weld heat treatment (PWHT)
- Hydrogen bakeout
- Shrink-fit applications



**Induction heating lowers operational costs because reaching target temperatures is dramatically faster.** That results in reduced consumable costs and labor expenses. In addition, it eliminates the expense of fuel gases and heating subcontractors.



**Welders are not exposed to open flame, explosive gases, and hot elements associated with flame and resistance heating.** Induction's method of heat transfer results in a cooler environment that reduces operator fatigue and improves work conditions.



**Time to temperature is dramatically faster than flame or resistance heating – reducing cycle time.** Setup and tear down times are quick, and unlike flame or resistance, induction allows continuous heating and fabrication.

### Induction heating applications:

- Process piping
- Refinery
- Petrochemical
- Power piping
- Pressure vessels
- Structural
- Shipbuilding
- Pipeline



### To learn more:

Contact your distributor or regional ITW Welding office.

## ProHeat 35 Power Source

The ProHeat 35 induction power source is equipped with a built-in temperature controller allowing for manual or temperature-based programming using up to four control thermocouples. At more than 90 percent efficiency, the ProHeat 35 power source transfers more energy to the part, reducing operating costs over different heating methods.

### Digital Recorder (optional)

The digital recorder is commonly used in stress relieving and critical preheat applications. The recorder stores temperature data based on time. It is not required to perform successful heating applications.

### Heavy-Duty Induction Cooler (optional)

Optimized for induction heating applications, cooler features a 9.5 L (2.5 gal.) rustproof polyethylene tank, high-pressure pump, and blower to yield a high cooling capacity.



ProHeat 35 power source shown with optional heavy-duty induction cooler, running gear and digital recorder.

Note: Primary input cable is not included with power source.





# INDUCTION HEATING

## One ProHeat™ System – Four Basic Induction Heating Configurations

ProHeat 35 induction heating systems solve preheating, post weld heat treatment (PWHT) and stress relieving problems.

### Liquid-Cooled Cables See literature IN/15.0

**Preheat applications up to 788°C (1,450°F).**

- A highly versatile tool for preheating, stress relieving, hydrogen bakeout, post weld heat treatment and shrink fit in a variety of pipe diameters and flat plate
- Designed with flexibility in mind, the ProHeat liquid-cooled induction heating cables can be wrapped into coils of various shapes and sizes to fit almost any induction heating application



### Liquid-Cooled Rolling See literature IN/13.0

**Preheat of moving parts up to 315°C (600°F).**

- Ideal for preheating rolling pipe and moving parts, with easy and time-saving setup and movement for maintaining and adhering to preheat and interpass temperatures
- Enables the benefits of rolled pipe welding while also addressing some of the concerns associated with other popular heating methods, such as open flame and resistance heating
- *Optional* infrared temperature sensor can read the temperature on the moving part from 100–400°C (212–750°F)
- *Optional* travel detect system can be used for setting different heating rates/ ramps based on workpiece speed travel – when no movement is detected the system turns off the output preventing damage to workpiece and rolling inductor



### Air-Cooled Blankets See literature IN/14.0

**Preheating applications up to 204°C (400°F).**

- Air-cooled blankets are available for pipe diameters from 20–152 cm (8–60 in.) or in the case of plate, the lengths are 1–5.2 m (41–205 in.)
- The blankets easily conform to circular and flat parts and install in a matter of seconds
- Manufactured from durable high-temperature materials, flexible induction blankets are designed to withstand the tough conditions in both industrial and construction applications



### Air-Cooled Cables See literature IN/14.0

**Preheating applications up to 200°C (392°F).**

- Air-cooled cables are available in lengths of 9.1 m (30 ft.), 15.2 m (50 ft.) or 24.4 m (80 ft.) for flexible configurations
- Designed with flexibility and efficiency in mind, the air-cooled cables can be wrapped into coils of various shapes and sizes to fit almost any induction preheating application, without the need for cooler and coolant
- Air-cooled cables provide the same flexibility as liquid-cooled cables for preheating





## ArcReach® Heater Air-Cooled Induction System

See literature IN/16.0

Field preheat and bakeout applications up to 315°C (600°F).



ArcReach Heater



Air-cooled cable

Air-cooled quick wrap

**ArcReach Heater systems are lightweight and portable for field preheating and bakeout applications, enhancing efficiency and economic advantages.** The induction heating tools (air-cooled cables or air-cooled quick wraps) connect to the ArcReach Heater, which is powered by select on-site welding power sources. With ArcReach Heater systems you can:

- Eliminate the costly overruns common with heating contractors
- Eliminate delays due to transitions between heating and welding crews
- Run your own schedule without depending on third-party contractors
- Use existing on-site welding equipment up to 61 m (200 ft.) away as the heating power source
- Automatically and accurately document joint temperatures
- Eliminate safety concerns caused by traditional resistance and open-flame heating

**Easy setup** with flexibility to fit a variety of pipe diameters, plates or odd geometries.

**Time-to-temperature** is faster than conventional processes due to the method of applying heat, reducing cycle time.

**Uniform heating** is maintained along and through the heat zone by using induction heat within the material.

**Improved working environment** during welding. Welders are not exposed to open flames, explosive gases and hot elements.

**ArcReach Heater** is equipped with built-in temperature control allowing for either manual or computer-loaded programming using up to six thermocouples. It can run either one or two heating tools (air-cooled cable or air-cooled quick wrap) at the same time. Requires ArcReach Heater extension cable to operate.



### Industrial ●

#### Process

- Induction heating

#### Suggested power sources

- XMT® 350 FieldPro™
- XMT® 650 ArcReach
- Big Blue® Series (ArcReach models only)

#### Most popular accessories



- ArcReach Heater Extension Cable 301451 3 m (10 ft.)
- Air-Cooled Quick Wrap 301452
- Air-Cooled Cable 301453030 9.1 m (30 ft.) 301453050 15.2 m (50 ft.) 301453080 24.4 m (80 ft.)
- Cable Cover 204611 9.1 m (30 ft.) 204614 15.2 m (50 ft.) 204620 24.4 m (80 ft.)

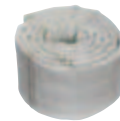

#### Preheat Insulation

- 204669 1.3 x 15 x 305 cm (1/2 x 6 x 120 in.)
- 195376 1.3 x 15 x 610 cm (1/2 x 6 x 240 in.)
- 211474 1.3 x 31 x 305 cm (1/2 x 12 x 120 in.)



#### Preheat Insulation w/Cable Harness

- 301334 1.3 x 41 x 305 cm (1/2 x 16 x 120 in.)
- Series Cable Adapter 195437
- High-Temperature Rope 194965
- Temperature Measurement (two options available) Contact Thermocouple Sensor (Probe) 301517 **OR** welded on thermocouples which require 152 m (500 ft.) Thermocouple Wire 194999, Thermocouple Connectors (10 pack) 195098, and Thermocouple Attachment Unit 194959

#### Stock Number

- 301390 Heater only – requires ArcReach Heater extension cable to operate
- 301591 Heater only, CE

#### Input Power

Operates on open-circuit voltage: 50-70 V provided by an XMT 350 FieldPro, XMT 650 ArcReach or a compatible ArcReach-equipped engine drive

#### Output Current

200 A

#### Output Voltage

300 V

#### Source Current

33 A

#### Output Frequency

5-30 kHz

#### Rated Output

7.8 kW at 100% duty cycle

#### Heater Dimensions

H: 472 mm (18.6 in.)  
W: 285 mm (11.2 in.)  
D: 678 mm (26.7 in.)

#### Heater Net Weight

20 kg (43 lb.)



# PLASMA CUTTERS

## Spectrum® Series Plasma Cutters

Our Spectrum line of plasma cutters provides big cutting power in portable packages and with features like flexible cables and Auto-Refire technology they are better than ever. Step up to Spectrum 625 X-TREME™ or 875/875 Auto-Line™ models to add Ultra-Quick Connect hand-held torches. Machine torch capabilities are available with Spectrum 875/875 Auto-Line™ models only.



Spectrum 375 X-TREME

Spectrum 625 X-TREME

Spectrum 875

Spectrum 875 Auto-Line

### Spectrum Features

Feature	375	625	875	875 Auto-Line
	X-TREME			
Auto-Line (120-240 V)	●	●		
Auto-Line (208-575 V)				●
MVP™ plugs/adapters	●	●		
Ultra-Quick Connect torch with flexible cable		●	●	●
Quick connect flexible work cable with clamp	●	●	●	●
Built-in gas/air filter and regulator	●	●	●	●
Auto-Refire	●	●	●	●
Auto postflow	●	●	●	●
Auto air regulation	●	●	●	●
X-CASE™	●	●		
Machine torch capable		●	●	●

### Steel/Stainless/Aluminum Rated Cutting Capacity

Spectrum	375 X-TREME		625 X-TREME		875/875 Auto-Line
	Steel/Stainless	Aluminum	Steel/Stainless	Aluminum	Steel/Stainless
	9.5 mm (3/8 in.)	6.4 mm (1/4 in.)	15.9 mm (5/8 in.)*	9.5 mm (3/8 in.)	22.2 mm (7/8 in.)
				15.9 mm (5/8 in.)	

\*Stainless: 12.7 mm (1/2 in.) for Spectrum 625 X-TREME.

Cut capacity ratings are based on traveling speed of approximately 381 mm (15 in.) per minute to achieve a precise cut. This is the key rating that should meet or exceed your typical cutting thickness requirements. Factors that can affect actual cut speeds, thickness capacity and duty cycles are: types of thermally conductive material being cut, available input power, output power settings and operator technique. For highly thermal conductive metals such as aluminum, cutting capacities may be reduced up to 30 percent compared to mild steel.

**Power factor correction (PFC).** Uses less energy by utilizing input power more efficiently and increases productivity by reducing nuisance circuit breaker trips.

**LED indicators for easy troubleshooting.**

**Non-high-frequency arc starting** does not interfere with or damage controls or computers.

**Postflow cooling circuitry** extends life of the consumable and torch by cooling them with postflow air after trigger is released.

**Auto-Refire™** provides ultimate convenience by automatically controlling the pilot arc when cutting expanded metal or multiple pieces of metal.

**Built-in gas/air filter and regulator.** Provides air filtration of airborne particles five microns and larger. Additional filtration and water separation recommended.

**LVC™ line voltage compensation** provides peak performance power under variable input voltage conditions for clean, steady cuts.

**Wind Tunnel Technology™** prevents abrasive dust and particles from damaging internal components.

**Fan-On-Demand™** cooling system only operates when needed, reducing the amount of airborne dust/dirt pulled through the unit.

**Quick connect flexible work cable with heavy-duty clamp.**

### Spectrum 625 X-TREME and 875/875 Auto-Line hand-held and machine torches



**Ultra-Quick Connect™ hand-held torches with flexible cables.**

XT40 (625 X-TREME) and XT60 (875 models) hand-held torches feature quick torch connection,

ergonomic handles to help prevent operator fatigue and flexible cables that make maneuvering easier.



**Machine torch capable.**

625 X-TREME and both 875 models can be ordered with a machine torch or can be converted to use a machine torch with optional automation kits.

**Long and short body machine torches.** XT40M (625 X-TREME) and XT60M (875 models) machine torches are available in long or short body configurations. XT60M is also available in 7.6 or 15.2 m (25 or 50 ft.) cable lengths.

### Models/packages



Spectrum 375 X-TREME hand-held torch package (907529) shown.



Spectrum 875 Auto-Line machine torch package (907584002) shown.

Model	Hand-Held Torch Packages			Long Body Machine Torch Packages	
	3.7 m (12 ft.)	6.1 m (20 ft.)	15.2 m (50 ft.)	7.6 m (25 ft.)	15.2 m (50 ft.)
Spectrum 375 X-TREME	(907529)	—	—	—	—
Spectrum 625 X-TREME	(907579)	(907579001)	—	—	—
Spectrum 875	—	(907583)	(907583001)	(907583002)	—
Spectrum 875 Auto-Line	—	(907584)	(907584001)	(907584002)	(907584004)





## Spectrum® 375 X-TREME™/625 X-TREME™

See literature PC/9.2 (375 X-TREME) and PC/9.6 (625 X-TREME)

**AUTO-LINE TECHNOLOGY** Allows for any input voltage hook-up (120–240 V, single-phase, 50/60 Hz for 375 X-TREME and 60 Hz for 625 X-TREME) with no manual linking, providing convenience in any job setting.

**X-CASE™** provides the ultimate protection during transport and storage. Additional space is ideal for MVP plugs, consumables box, gloves, etc.

**Multi-voltage plug (MVP™) on 375 X-TREME or MVP™ adapter on 625 X-TREME** allows connection to 120- or 240-volt receptacles without tools.

**Automatic air regulation** compensates for input pressure variation to provide constant recommended torch pressure for optimum cutting performance.

**Automatic gouging consumable detection (625 X-TREME only).** Detects gouging consumable and adjusts gas pressure to optimize performance, eliminating the need for a manual regulator.



Spectrum 625 X-TREME shown.

**375 X-TREME model includes XT30 hand-held torch** with ergonomic design and flexible cable.

**625 X-TREME model includes Ultra-Quick Connect™ XT40 hand-held torch** with ergonomic design and flexible cable; or **XT40M long body or short body machine torch.**

## Spectrum® 875/875 Auto-Line™

See literature PC/9.8

**AUTO-LINE TECHNOLOGY** **Spectrum 875 Auto-Line model** allows for any input voltage hook-up (208–575 V, single- or three-phase) with no manual linking, providing convenience in any job setting. *Standard Spectrum 875 model operates on 208/230 V, single-phase input voltage only.*

**Consumables storage compartment** provides convenient access to consumables and parts.

**Automatic air regulation** compensates for input pressure variation to provide constant recommended torch pressure for optimum cutting performance.



Spectrum 875 shown.

**Includes Ultra-Quick Connect™ XT60 hand-held torch** with ergonomic design and flexible cable; or **XT60M long body or short body machine torch.**

**Light industrial** ● 375/625 models  
**Industrial** ● 875 models

**DC 3 1** Only 875 Auto-Line has 3-phase capabilities.

### Processes

- Air plasma cutting
- Air plasma gouging (625/875 models)

### 375 X-TREME package comes complete with

- XT30 hand-held torch with 3.7 m (12 ft.) cable
- Heavy-duty work clamp with 3.7 m (12 ft.) flexible cable
- 3 m (10 ft.) power cord with MVP 5-15P (120 V, 15 A) and 6-50P (240 V, 50 A) plugs
- X-CASE for protection and storage
- Shoulder strap
- Consumables box with two electrodes, two tips, deflector and air fitting

### 625 X-TREME packages come complete with

- XT40 hand-held torch with 3.7 m (12 ft.) or 6.1 m (20 ft.) cable **OR** XT40M long body or short body machine torch with 7.6 m (25 ft.) cable
- Heavy-duty work clamp and flexible cable with quick connect
- 3.7 m (12 ft.) power cord with 240 V, L6-30P twist lock plug
- MVP adapters with 5-15P (120 V, 15 A) and 6-50P (240 V, 50 A) plugs
- X-CASE for protection and storage
- Shoulder strap
- Consumables box with two electrodes, two 40 A tips and one 30 A tip, 30 A drag shield, deflector and air fitting
- Machine torch packages include corresponding automation kit

### 875 and 875 Auto-Line packages come complete with

- XT60 hand-held torch with 6 m (20 ft.) or 15.2 m (50 ft.) cable **OR** XT60M long body or short body machine torch with 7.6 m (25 ft.) or 15.2 m (50 ft.) cable
- Heavy-duty work clamp and flexible cable with quick connect
- 3 m (10 ft.) power cord
- Extra consumables
- Machine torch packages include corresponding automation kit

### Most popular accessories

- Automation Kits
- Cables and Cable Covers
- Cutting Guides
- Filters
- Plugs and Cords
- Protective Covers/Cases
- Torches
- Torch Consumables

Model	Input Power	Rated Output at 40°C (104°F)	Amps Input at Rated Output	KVA	KW	Compressor Requirement	Dimensions	Net Weight with Torch
Spectrum 375 X-TREME 120–240 V, 50/60 Hz	Single-phase	120 V (15 A): 20 A at 88 VDC, 35% duty cycle	18.1	2.2	2.1	142 L/min. (5.0 cfm) at 621 kPa (90 psi)	H: 229 mm (9 in.) W: 140 mm (5.5 in.) D: 337 mm (13.25 in.)	8.6 kg (19 lb.)
		120 V (20 A): 27 A at 91 VDC, 20% duty cycle	25.6	3.1	3.0			
		240 V: 30 A at 92 VDC, 35% duty cycle	13.6	3.3	3.1			
Spectrum 625 X-TREME 120–240 V, 60 Hz	Single-phase	120 V (15 A): 20 A at 88 VDC, 35% duty cycle	18.1	2.2	2.1	170 L/min. (6.0 cfm) at 621 kPa (90 psi)	H: 229 mm (9 in.) W: 140 mm (5.5 in.) D: 337 mm (13.25 in.)	<b>3.7 m (12 ft.)</b> 9.5 kg (21 lb.) <b>6.1 m (20 ft.)</b> 10.5 kg (23 lb.) <b>7.6 m (25 ft.)</b> 10.7 kg (24 lb.)
		120 V (20 A): 27 A at 91 VDC, 20% duty cycle	25.6	3.0	2.9			
		240 V: 40 A at 140 VDC, 50% duty cycle	13.6	6.4	6.3			
Spectrum 875 208/230 V, 50/60 Hz	Single-phase	208 V: 60 A at 140 VDC, 40% duty cycle	208 V: 47	9.9	9.8	191 L/min. (6.75 cfm) at 621 kPa (90 psi)	H: 343 mm (13.5 in.) W: 222 mm (8.75 in.) D: 470 mm (18.5 in.)	<b>6.1 m (20 ft.)</b> 22.2 kg (49 lb.) <b>15.2 m (50 ft.)</b> 26.3 kg (58 lb.)
		230 V: 60 A at 140 VDC, 50% duty cycle	230 V: 42					
Spectrum 875 Auto-Line 208–575 V, 50/60 Hz	Three-phase	208 V: 60 A at 140 VDC, 40% duty cycle	208 V: 27.5	9.9	9.4			<b>6.1 m (20 ft.)</b> 24.5 kg (54 lb.) <b>7.6 m (25 ft.)</b> 25.4 kg (56 lb.) <b>15.2 m (50 ft.)</b> 28.6 kg (63 lb.)
		230–380 V: 60 A at 140 VDC, 50% duty cycle	230 V: 25					
		380–575 V: 60 A at 140 VDC, 60% duty cycle	380 V: 15					
Spectrum 875 Auto-Line 208–575 V, 50/60 Hz	Single-phase	460 V: 12.4	460 V: 12.4	9.9	9.7			
		575 V: 9.8	575 V: 9.8					
Spectrum 875 Auto-Line 208–575 V, 50/60 Hz	Single-phase	208 V: 60 A at 140 VDC, 40% duty cycle	208 V: 47.4	9.9	9.7			
		230 V: 60 A at 140 VDC, 40% duty cycle	230 V: 42.2					
		230 V: 50 A at 140 VDC, 100% duty cycle						



## Respiratory

### PAPR Systems

PAPR (Powered Air Purifying Respirator) systems consist of blower assembly, HEPA filter, prefilters (6), spark guard, breathing tube, breathing tube cover, padded belt, comfortable shoulder straps, lithium-ion batteries (2), battery charger, flowmeter, tool bag, and helmet assembly **OR** helmet assembly with integrated hard hat **OR** face shield assembly with clear shield (see packages at right).

- HEPA filter provides up to 99.97 percent filtration of airborne particulate
- NIOSH 42 CFR 84 certified, assigned protection factor of 25 with standard head seal **OR** 1,000 with optional heavy-duty head seal (Hard Hat and Face Shield only)

#### Designed for comfort

**Well-balanced design** reduces torque on neck, increasing all-day wear.

**Patent-pending Dualtec™ manifold system** optimizes helmet balance and sound, while **six-point air distribution system** maximizes cooling through targeted air placement.

**Ergonomic headgear (T94-R and Face Shield)** provides secure fit without the need for over-tightening.

**MSA Fas-Trac® III ratchet-suspension headgear (Hard Hat)** provides exceptional comfort, reducing pressure points while increasing stability.

**Lightweight low-profile blower assembly with integrated shoulder straps** reduces lower back strain and fatigue.

#### Superior visibility

**ClearLight™ Lens Technology (T94-R)** provides high-definition optics for precision arc recognition.

**ClearLight™ 2.0 Lens Technology (Hard Hat)** provides advanced high-definition optics for the most realistic view that's clearer and brighter – before, during and after every weld.

**Shade 5.0 side windows and oversized clear grind shield** maximize downward and peripheral visibility, improving sense of surroundings.

**Half-shade lens adjustability** provides fine shade adjustment for optimized comfort and vision.

**Large integrated grind shield (T94i-R and Hard Hat)** provides 44 sq. in. of clear viewing area for grinding and other tasks.

**High-Definition View (HDV) technology (Hard Hat and Face Shield)** for a sharp

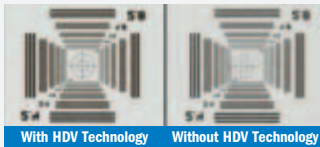

detailed view at any angle with minimal distortion.

#### Improved productivity

**Enhanced comfort, cooling and visibility** maximize all-day wearability – increasing productivity, safety and regulatory compliance.

**Low-profile breathing-tube attachment** eases on/off process while flexible tube material reduces breathing tube snags in work cell.

**Two lightweight lithium-ion batteries** included with each package eliminate downtime.



T94-R

T94i-R

**T94-R™ PAPR** See literature AY/4.1

**With T94-R™ helmet (external grind control)**

**264573** With auto-darkening lens assembly

**With T94i-R™ helmet (integrated clear grind shield)**

**264575** With auto-darkening lens assembly

**T94-R™ helmet upgrade kit (for use with existing PAPR system)**

**279870** Includes T94-R helmet assembly, breathing tube, breathing tube cover and flowmeter

**T94i-R™ helmet upgrade kit (for use with existing PAPR system)**

**279871** Includes T94i-R helmet assembly, breathing tube, breathing tube cover and flowmeter

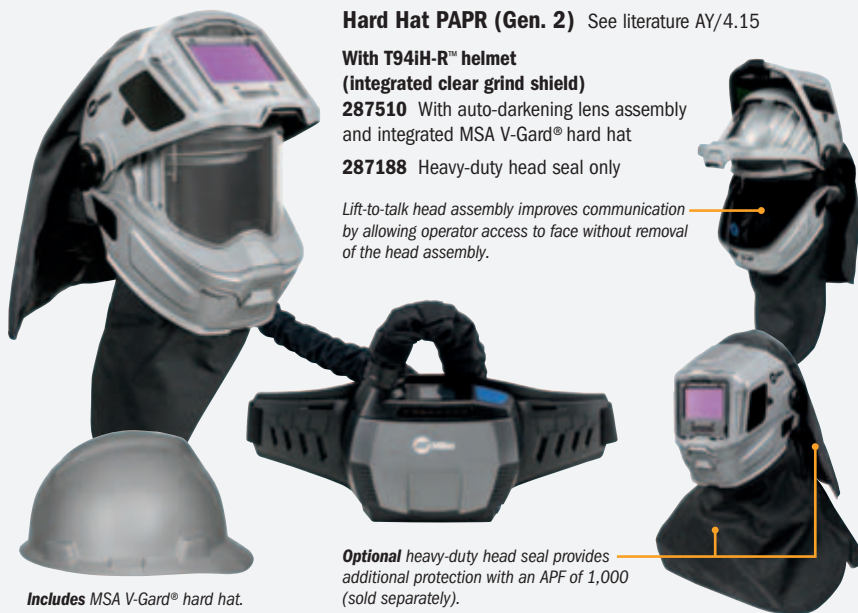

**Hard Hat PAPR (Gen. 2)** See literature AY/4.15

**With T94iH-R™ helmet (integrated clear grind shield)**

**287510** With auto-darkening lens assembly and integrated MSA V-Gard® hard hat

**287188** Heavy-duty head seal only

*Lift-to-talk head assembly improves communication by allowing operator access to face without removal of the head assembly.*

*Optional heavy-duty head seal provides additional protection with an APF of 1,000 (sold separately).*

*Includes MSA V-Gard® hard hat.*

**Face Shield PAPR (Gen. 2)**

See literature AY/4.2

**288356** With HDV face shield

**288346** Heavy-duty head seal only



*Optional heavy-duty head seal provides additional protection with an APF of 1,000 (sold separately).*



## Respiratory

### SAR Systems



Coiled air hose

Straight air hose

**T94i-R™ SAR** See literature AY/4.3

**With T94i-R™ helmet (integrated clear grind shield)**

- 951800** With auto-darkening lens assembly and 7.6 m (25 ft.) straight air hose
- 951801** With auto-darkening lens assembly and 30.5 m (100 ft.) straight air hose
- 951802** With auto-darkening lens assembly and 7.6 m (25 ft.) coiled air hose
- 951803** With auto-darkening lens assembly and 30.5 m (100 ft.) coiled air hose
- 264871** With auto-darkening lens assembly (air hose not included)

**T94i-R™ helmet upgrade kit (for use with existing SAR system)**

- 279871** Includes T94i-R helmet assembly, breathing tube, breathing tube cover and flowmeter

SAR (Supplied Air Respirator) systems consist of C50 air regulator, belt assembly, flowmeter, breathing tube, breathing tube cover, tool bag, T94i-R helmet assembly and air hose (see packages at left).

- NIOSH 42 CFR 84 certified, assigned protection factor of 25. To provide a NIOSH-approved respiratory system, the SAR with T94i-R must be used with Miller® helmet, hoses, connectors, filters and other components recommended by Miller

**Well-balanced design** reduces torque on neck, increasing all-day wear.

**Patent-pending Dualtec™ manifold system** optimizes helmet balance and sound, while **six-point air distribution system** maximizes cooling through targeted air placement.

**Ergonomic headgear** provides secure fit without the need for over-tightening.

**Lightweight versatile C50 air regulator** can be positioned horizontally or vertically to naturally align with body movements.

**ClearLight™ Lens Technology** provides high-definition optics for precision arc recognition.

**Shade 5.0 side windows and oversized clear grind shield** maximize downward and peripheral visibility, improving sense of surroundings.

**Half-shade lens adjustability** provides fine shade adjustment for optimized comfort and vision.

**Large integrated grind shield** provides 44 sq. in. of clear viewing area for grinding and other tasks.

**Enhanced comfort, cooling and visibility** maximize all-day wearability – increasing productivity, safety and regulatory compliance.

**Low-profile breathing-tube attachment** eases on/off process while flexible tube material reduces breathing tube snags in work cell.

**C50 air regulator** cools Grade-D breathing air by up to 28°C (50°F) under your hood, heightening productivity and relieving heat stress. Performance under different applications may vary. 360-degree swivel air hose connection alleviates hose coiling, reducing potential trip hazards.

Also available



**BreatheAir™ portable box**

- 275983** Two person, 10 ppm alarm
  - 275985** Four person, 10 ppm alarm
- Supplies Grade-D breathing air while monitoring for CO.

**Monitor calibration kit**

- 275988** 10 ppm



**BreatheAir™ panel**

- 275961** Two person, 10 ppm alarm
  - 275970** Four person, 10 ppm alarm
- Supplies Grade-D breathing air while monitoring for CO.

**Monitor calibration kit**

- 275988** 10 ppm

### Half Mask Respirators



**LPR-100™ OV Half Mask Respirator**

See literature AY/4.5

- ML00996** Respirator with P100 organic vapor filters (small/medium)
- ML00997** Respirator with P100 organic vapor filters (medium/large)

**Filters and accessories**

- SA00820** P100/OV filters (one pair)
- 285686** Protective hard carrying case
- 261086** Quantitative fit-test kit adapter

- Low-profile design fits under T94™ and Digital Elite™ welding helmets and provides maximum field of vision.
- P100/OV filters provide up to 99.97 percent filtration of specific organic vapors and airborne particulates
- NIOSH 42 CFR 84 certified, assigned protection factor of 10



**LPR-100™ Half Mask Respirator**

See literature AY/4.5

- ML00894** Respirator with P100 filters (small/medium)
- ML00895** Respirator with P100 filters (medium/large)
- ML00994** Respirator with P100 nuisance level OV relief filters (small/medium)
- ML00995** Respirator with P100 nuisance level OV relief filters (medium/large)

**Filters and accessories**

- SA00818** P100 filters (one pair)
- SA00819** P100 nuisance level OV relief filters (one pair)
- 283374** Protective hard carrying case
- 261086** Quantitative fit-test kit adapter

- Low-profile design fits under T94™, Digital Elite™ and Classic welding helmets and provides maximum field of vision.
- P100 filters provide up to 99.97 percent filtration of airborne particulates
- Nuisance level OV relief filters are designed for use with organic vapor concentrations not exceeding OSHA's PELs or other applicable government occupational exposure limits, whichever is lower
- NIOSH 42 CFR 84 certified, assigned protection factor of 10





## Welding Helmets

Helmets with *ClearLight 2.0* have a four-year warranty. Classic Series helmets have a three-year warranty.

	T94i™ XL	T94i™	T94™	Digital Infinity™	Digital Elite™	Digital Performance™	Classic VSI™	Classic VS	Classic FS#10 Flip-Up
Viewing Area	13 sq. in.	9 sq. in.	9 sq. in.	Largest Viewing Area 13.4 sq. in.	9.2 sq. in.	7.2 sq. in.	5.9 sq. in.	6 sq. in.	5.1 sq. in.
Auto-Darkening	Yes	Yes	Yes	Yes	Yes	Yes	Yes	Yes	Yes
ClearLight™ Lens Technology	—	—	—	—	—	—	Yes	Yes	Yes
ClearLight™ 2.0 Lens Technology	Yes	Yes	Yes	Yes	Yes	Yes	—	—	—
AutoSense™	—	—	—	Yes	Yes	Yes	—	—	—
Modes	Weld/Cut/X-Mode/ Flip grind	Weld/Cut/X-Mode/ Flip grind	Weld/Cut/X-Mode/ External grind	Weld/Cut/X-Mode/ Grind	Weld/Cut/X-Mode/ External grind or Grind	Weld/Cut/ Grind	Weld/X-Mode/ Flip grind	Weld/Cut/ Grind	Weld/ Flip grind
Shades	Weld: 8-14 Cut: 5-8	Weld: 8-14 Cut: 5-8	Weld: 8-14 Cut: 5-8 Grind: 3	Weld: 8-13 Cut: 5-8 Grind: 3	Weld: 8-13 Cut: 5-8 Grind: 2.5 or 3	Weld: 8-13 Cut: 5-8 Grind: 3	Weld: 8-13	Weld: 8-13 Cut: 5-8 Grind: 3	Weld: 10
Integrated Grind Shield	Yes	Yes	—	—	—	—	Yes	—	Yes
Auto-on	Yes	Yes	Yes	Yes	Yes	Yes	Yes	Yes	Yes
Sensors	4	4	4	4	4	3	3	2	2
TIG Rating	3 amps	3 amps	3 amps	5 amps/below	5 amps/below	5 amps	5 amps/below	5 amps/below	20 amps
Switching Speed	1/25,000 second	1/25,000 second	1/25,000 second	1/25,000 second	1/25,000 second	1/25,000 second	1/20,000 second	1/23,000 second	1/3,600 second
Digital Controls	Yes	Yes	Yes	Yes	Yes	Yes	—	Yes	—
Premium Headgear	Yes	Yes	Yes	Yes	Yes	Yes	—	—	—
HDV Technology	Yes	Yes	Yes	—	—	—	—	—	—
InfoTrack™ 2.0	Yes	Yes	Yes	Yes	Yes	—	—	—	—
Weight	794 g (28 oz.)	737 g (26 oz.)	599 g (21 oz.)	652 g (23 oz.)	510 g (18 oz.)	482 g (17 oz.)	652 g (23 oz.)	454 g (16 oz.)	396 g (14 oz.)
Warranty	4 years	4 years	4 years	4 years	4 years	4 years	3 years	3 years	3 years

See chart above for feature availability.

**ClearLight™ Lens Technology** provides high-definition optics for precision arc recognition.

**ClearLight™ 2.0 Lens Technology** provides advanced high-definition optics for the most realistic view that's clearer and brighter – before, during and after every weld.

**AutoSense™** reduces issues related to setting helmet sensitivity by allowing the welder to push and hold the AutoSense button to automatically set the helmet sensitivity for their environment.

**X-Mode.™** Electromagnetically senses the weld to reduce sunlight interference and continuously detects the arc even if sensors are blocked.

**High-Definition View (HDV) technology.** The curve of traditional lens designs can often times distort or blur your view. HDV technology provides a sharp detailed view at any angle with minimal distortion.

**InfoTrack™ 2.0 data monitoring technology** tracks arc time and arc count.

## T94™ Series Maximized comfort, visibility and productivity for the professional welder.

See literature AY/41.1



**Matte silver finish** reflects ambient heat, keeping the user cooler.

**Four operating modes** for ultimate versatility: weld, cut, X-Mode™ and grind.

**Half-shade settings** for precise lens adjustment.

**Simplistic digital lens interface** allows for easy adjustment with or without gloves.

**Shade 5.0 side windows** enhance peripheral vision, amplifying sense of surroundings.

**Chiseled shell design** provides optimal skin coverage while easily accommodating a Miller® Half Mask Respirator.

**Gen IV premium headgear** with four-point flexible design provides a secure fit, while avoiding major pressure points within the head, maximizing all-day wear. Customizable fit with seamless tilt, distance and tightness adjustments.

**HDV technology** provides a sharp detailed view at any angle with minimal distortion on integrated grind shield (T94i XL/T94i) and quick-release one-piece cover lens (all models).

### Best-in-class comfort for all-day wearability

Lightweight, well-balanced design reduces neck torque, minimizing operator fatigue and strain, leading to an increase in comfort.



**4% LIGHTER** for reduced fatigue



**14% BETTER BALANCE** for elevated comfort



**17% LESS TORQUE** for reduced neck strain

Statistics above compare T94i to previous model.

### Helmet Lighting Accessory 281361

- Provides additional lighting in low-light environments for T94 welding helmets
- Includes two lights (one for each side) and all required mounting hardware





## Digital Infinity™ Series Largest viewing area maximizes visibility. See literature AY/42.5



**Black**  
289714, CE

**Black Ops™**  
289715, CE

**Departed™**  
289720, CE

**Stars and Stripes™**  
288420

**Relic™**  
288722

**Imperial™**  
288725

**'22 Custom Kindig-it**  
292933

**NEW!**  
**Honor™**  
280054

## Digital Elite™ Series Industry-leading helmet provides high-performance versatility.

See literature no. AY/43.5 (External Grind) and AY/43.0 (all others)



**Black w/External Grind**  
288924, CE

**Black**  
289755, CE

**Lucky's Speed Shop™**  
289756, CE

**Stars and Stripes™ III**  
289759, CE

**Inferno™**  
289762, CE

**Vintage Roadster™**  
289764, CE

**Raptor™**  
289768, CE

**Gear Box™**  
289844

**Blue Rage™ II**  
281010

## Digital Performance™ Series Lightweight helmet with superior headgear for ultimate comfort. See literature AY/44.0



**Black**  
289842, CE

**Blue Rage™**  
289802, CE

**'64 Custom™**  
289807, CE

**Crusher™**  
289808

**Unity™**  
282006

### Helmet Lighting Accessory 282013

- Provides additional lighting in low-light environments for most Miller® welding helmets including Infinity, Elite, Performance, Classic and MP-10
- Includes two lights (one for each side) and all required mounting hardware



## Classic Series Helmets for the value-minded welder. See literature AY/45.5



**VSi™**  
287794

**Black (VS)**  
287803, CE

**Metalworks™ (VS)**  
287810, CE

**Rise™ (VS)**  
287815, CE

**Liberty™ (VS)**  
287820

**Metal Matrix™ (VS)**  
288519

**Hex™ (VS)**  
291189

**FS#10 Flip-Up**  
287798

## MP-10™



**Black**  
238497

**Best-in-class traditional passive shade 10 lens helmet.**



## Welding Helmet Accessories



### Slotted Hard Hat Adapter 259637

- Compatible with most slotted hard hats. Helmet and hat not included



### Hard Hat Adapter 265315

- For T94™ welding helmets
- 222003 For Titanium™, Infinity™, Elite™, Performance™, Classic and MP-10™ welding helmets
- Compatible with most Fibre Metal and MSA hats. Other brands may fit depending on size and shape. Helmet and hat not included



### Headgear 290460

- 290460 **NEW!** Legacy (shown)
- 260486 Gen. IV
- 770246 Classic



### 2x4 Auto-Darkening Lens with ClearLight™ Lenses Technology

- 287828 Shade 9
- 287830 Shade 10
- 287833 Shade 11
- Fits all 2x4-inch windows
- Solar powered
- Two arc sensors
- Two-year warranty

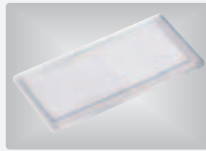

### Magnifying Lens

- 212235 0.75 magnification
- 212236 1.00 magnification
- 212237 1.25 magnification
- 212238 1.50 magnification
- 212239 1.75 magnification
- 212240 2.00 magnification
- 212241 2.25 magnification
- 212242 2.50 magnification
- 4.25 x 2 x 5/23 inch lens for all Miller® helmets



### Helmet Bib 253882

- Flame-resistant WeldX™ material provides additional neck coverage for the Infinity, Elite, Performance, Classic and MP-10 welding helmets



### Helmet Bib 279078

- Flame-resistant material provides additional neck coverage for the T94 welding helmets



### Helmet Cape 279080

- Flame-resistant material provides additional head and back-of-the-neck coverage for the T94 welding helmets



### Helmet Hook 251018

- Holds welding helmets, grinding shields or other helmets with a headgear
- Silicone strap secures the helmet in place



### Jobsite Tool Bag 228028

- Over twenty separate pockets
- Opening of 305 x 470 mm (12 x 18.5 in.)



### CoolBelt™ Belt-Mounted Cooling System 245230

- Up to **-8°C (17°F) cooler** under the hood
- Provides all-day comfort through maximized airflow power
- Multiple airflow speeds eliminate stagnant air and reduce fogging
- Lightweight design extends wearability
- Compatible with Infinity, Elite, Performance, Classic and MP-10 welding helmets

## Weld-Mask™ See literature AY/40.0

Compact auto-darkening lenses allow users to weld in spaces where access with traditional welding helmets is limited. Close-fitting soft eye covering provides total darkness for precision welding. Face shield and flame-retardant head cover provide coverage for UV/IR rays and applications with limited spatter. Two-year warranty.



### Weld-Mask 267370

- Shades 5, 7, 9, 11 and 13 for use with MIG, TIG, stick, and gas welding and cutting
- Extremely lightweight (227 g [8 oz.]), virtually eliminates neck strain

### Weld-Mask 2 280982

- Ideal for industrial or construction environments — can be worn under a hard hat with a Miller® Half Mask Respirator and select safety glasses
- Shades 5-13 for use with MIG, TIG, stick, and gas welding and cutting
- X-Mode™ electromagnetically senses the weld to reduce sunlight interference and continuously detects the arc even if sensors are blocked
- Wide, singular lens provides unmatched auto-darkening range of visibility



### Weld-Mask 2 Lighting Accessory 281188

- Snaps onto brow of Weld-Mask 2 model to provide additional lighting in low-light environments

### Weld-Mask Hard Hat Adapters 285757

- Snaps onto sides of most slotted hard hats to secure Weld-Mask

## Safety Glasses See literature AY/46.0



- Anti-fog coating and high-quality optics
- Form-fitting orbital eye coverage
- Shatterproof polycarbonate lenses
- Wrap-around designs meet ANSI side shield requirements
- ANSI Z87.1+ compliant
- I/O (indoor/outdoor) lenses feature light shading with a mirrored finish
- Shade 3 and 5 IR lenses are for cutting, brazing or soldering

### Safety and Cutting Glasses Chart

Frame Style (Color)	Clear Lenses	I/O Lenses	Shade 3 Lenses	Shade 5 Lenses
Classic (Black)	272187	—	—	—
Spatter™ (Black)	272191	—	—	—
Spark™ (Black/Blue)	272190	—	—	—
Slag™ (Black)	272201	272202	—	272205
Gen I (Black)	—	—	235662	235658





## Face Shield Series

See literature AY/46.5



### Face Shield

- 288269** Clear
- 288274** Clear + Anti-Fog
- 288270** Shade 3
- 288273** Shade 5

- HDV technology for a sharp detailed view at any angle without distortion
- Impact-resistant shield for increased durability and protection
- Lightweight design for all-day wear and comfort
- Clear + Anti-Fog lens coating prevents fogging for enhanced visibility
- Shade 3 and 5 lenses provide protection for cutting, brazing or soldering applications
- Made of polycarbonate material that provides 99.9 percent UVA/UVB/UVC protection to help prevent eye damage
- ANSI Z87.1 compliant



**Halo Hard Hat Adapter**  
**222003**

**Slotted Hard Hat Adapter Clips**  
**(not shown) 259637**

## Welding Gloves

See literature AY/47.0

**Performance – exceptional comfort and performance combined with dexterity and flexibility.**



### Heavy-Duty MIG/Stick

- Strategically placed patches on palm and back for extended glove life
- Double-layered insulated palm and back
- Pig grain leather palm provides extreme durability and protection

### MIG (Lined)

- Dual-padded palm
- Fleece-insulated palm, foam-insulated back
- Cow grain palm, pig split back and goat grain inner fingers provide exceptional dexterity and comfort

### TIG

- Completely unlined for heightened feel and dexterity
- Triple-padded palm for added comfort
- Goat grain leather offers superior flexibility and dexterity

### TIG/Multitask

- Dual-padded palm for added comfort
- Wool back provides ultimate insulation
- Goat grain leather offers superior flexibility and dexterity

### Metalworker

- Durable top grain leather and spandex back for enhanced durability and dexterity
- Neoprene wrist with hook-and-loop closure increases fit and support
- Padded, reinforced palm and thumb saddle for extended wear

**Classic – traditional design for the value-minded welder.**



### Heavy-Duty MIG/Stick

- Reflective insulation on back reduces heat impact
- Moisture-wicking fleece and foam insulation
- Pig grain palm, pig split back and cuff

### MIG (Pigskin)

- Reinforcement patches enhance durability
- Moisture-wicking fleece and foam insulation
- Pig split leather palm, back and cuff

### MIG (Cowhide)

- Reinforcement patches enhance durability
- Moisture-wicking fleece and foam insulation
- Cow split palm, pig split back and cuff

### TIG

- Thin internal padding for added comfort
- Unlined palm for precise dexterity
- Sheep grain palm, cow split back and cuff

### Work

- Dual-padded palm for added durability
- Fleece back provides ultimate insulation
- Cow grain leather offers superior durability and abrasion resistance

**Cut-resistant – exceptional comfort, performance and protection.**



- ANSI A5 cut rating, level 4 puncture and abrasion rating, and level 3 heat rating
- Designed with pre-curved fingers for ergonomic fit and exceptional comfort
- Ergonomic wrist design for additional comfort
- Goat grain palm, cow split back and cuff, with Kevlar® flame-resistant thread
- Drag patch for enhanced durability (TIG)

**Welding Glove Size Chart** \*All asterisked stock numbers are sold as one pair. All others are sold as six packs (six pairs).

Performance	Small	Medium	Large	X-Large	2X-Large	Classic	Medium	Large	X-Large	Cut-Resistant	Small	Medium	Large	X-Large	2X-Large
Hy-Duty MIG/Stick	–	–	263339	263340	269615*	Hy-Duty MIG/Stick	–	271877*	271887*	MIG	290412*	290413*	290414*	290415*	290416*
MIG (Lined)	–	263332	263333	263334	269618*	MIG (Pigskin)	–	279875*	279876*	TIG	290401*	290402*	290403*	290404*	290411*
TIG	263346	263347	263348	263349	–	MIG (Cowhide)	–	271890*	271891*						
TIG/Multitask	263352	263353	263354	263355	–	TIG	279897*	279898*	279899*						
Metalworker	–	251066	251067	251068	–	Work	266041*	266042*	266043*						



## Welding Apparel

See literature AY/47.5



### Grain Leather Jacket (See size chart)

- Top-grain pigskin leather
- Expandable leather strategically placed for optimal mobility
- Flame-resistant inside cuff
- Satin lining
- Tapered, athletic cut
- Sewn entirely with Kevlar® thread, adding structural durability at each seam



### Split Leather Jacket (See size chart)

- Premium pig split leather
- Extended rear tail for additional protection
- Expandable leather strategically placed for optimal mobility
- Mesh lining
- Sewn entirely with Kevlar® thread, adding structural durability at each seam



### WeldX™ Jacket (See size chart)

- 7-ounce WeldX front and flame-resistant navy cotton back
- Lightweight exclusive material with extreme flame-resistant properties
- Vented back/extended rear tail
- Zipper closure with hook-and-loop fastened flap
- Chromium free for easy disposal



### Combo Jacket (See size chart)

- 9-ounce Indura® flame-resistant cotton (flame resistance guaranteed for life of jacket)
- Top-grain leather
- Pre-shrunk fabric



### Indura® Cloth Jacket (See size chart)

- 9-ounce Indura® flame-resistant cotton (flame resistance guaranteed for life of jacket)
- Pre-shrunk fabric



### Classic Cloth Jacket (See size chart)

- 9-ounce flame-resistant navy cotton
- Pre-shrunk fabric
- Fold-in sleeve snaps
- Finished hems and reinforced stitching

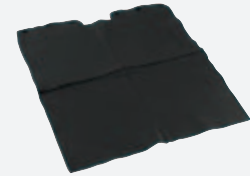

### Leather Bib/Apron 231125

- Attaches to combo jacket with snaps across the chest as a bib or along the bottom as an apron



### Combo Sleeves 231096

- Indura® flame-resistant cotton/top-grain leather
- .5 m (21 in.) length



### Classic Cloth Sleeves 247148

- .46 m (18 in.) length
- Fold-in sleeve snaps
- Upper arm elastic band



### Classic Cloth Apron 247149

- .9 m (35 in.) length with accessible front pocket
- Adjustable drawstring ensures a good fit

Note: Indura® is a registered trademark of Westex® by Milliken™ used under license by IFR Workwear Inc.

### Welding Apparel Size Chart

Apparel	Small	Medium	Large	X-Large	2X-Large	3X-Large	4X-Large	5X-Large
Grain Leather Jacket	—	—	231090	231091	231092	—	—	—
Split Leather Jacket	273212	273213	273214	273215	273216	273217	273218	273219
WeldX Jacket	247114	247115	247116	247117	247118	247119	247120	247121
Combo Jacket	—	231081	231082	231083	231084	—	—	—
Indura Cloth Jacket	—	258097	258098	258099	258100	—	—	—
Classic Cloth Jacket	244749	244750	244751	244752	244754	244755	244756	244758



For more detailed information, visit

MillerWelds.com/arcstation

# WORKSTATIONS



Count on Miller to design the perfect workbench to make welding projects faster and easier. The ArcStation is the first-ever, all-in-one workstation designed for welding and metalworking. It's versatile, affordable and just the right height to work comfortably. You can organize equipment, tools, and raw materials into one convenient workspace.

## ArcStation™ 60SX Fully Loaded

The 60SX Fully Loaded is perfect for the welder who needs a tough workbench for the fab shop or the home garage.



60SX Fully Loaded

**.76 x 1.52 m (30 x 60 in.) size tabletop** provides double the work surface of the 30FX.

**9.5 mm (3/8 in.) X-pattern steel tabletop** allows trouble-free clamping.

**Durable 3.2 mm (1/8 in.) steel frame with cross bar and heavy-duty tabletops** provide a sturdy area for welding or metalworking.

**Adjustable leveling feet** keep workbench rock-steady.

**Comes customized with a wide range of handy accessories** to make this the *ultimate* workbench (see at right for replacement accessories).

### ArcStation 60SX accessories

Miller® ArcStation accessories allow you to get the most out of your ArcStation.

- 1 6-inch X-clamp** 300613
- 2 Side Shelf** 300680
- 3 Tool Chest with ball-bearing slides** 300610
- 4 5-inch Quick-Remove Vise with mount** 300611
- 5 Weld Curtain** 300686
- 6 Casters** 300849



**Convenience Kit** 300614  
Includes the following:

- 7 Gun holder**
- 8 Tool holder**
- 9 Clamp bar**



### Popular system components

- Steel frame 1.52 m (60 in.) 300604
- Dust tray 300605
- Table top solid .76 x .76 m (30 x 30 in.) 300606
- Table top X pattern .76 x .76 m (30 x 30 in.) 300607

## ArcStation™ 30FX

When portability or space-savings is a concern, the ArcStation 30FX is your solution.



30FX shown with two 152 mm (6 in.) X-clamps (sold separately).

**Wheels, handle, and fold-up design** make unit easy to take to the jobsite or move around the shop.

**Compact size** makes storing unit a breeze. Unit folds down to 152 x 737 x 1219 mm (6 x 29 x 48 in.).

**.76 x .76 m (30 x 30 in.) size tabletop** provides plenty of work surface.

**4.8 mm (3/16 in.) X-pattern steel tabletop** allows trouble-free clamping.

**38.1 mm (1.5 in.) diameter steel tube frame** provides strength and durability.

**Includes removable gun holder.**

**Add optional 152 mm (6 in.) X-clamp (300613)** to make this the *ultimate* portable workbench.

Model/Stock Number	Steel Top	Load Capacity	Dimensions	Weight
60SX				
30FX (300837)	(1) 737 x 737 x 4.8 mm (29 x 29 x 3/16 in.) X-pattern	227 kg (500 lb.)	889 x 737 x 889 mm (35 x 29 x 35 in.)	34 kg (74 lb.)





# TRAINING SOLUTIONS

For more detailed  
information, visit



[MillerWelds.com/trainingsolutions](http://MillerWelds.com/trainingsolutions)



**AugmentedArc®**  
Augmented Reality Welding System



**LiveArc™**  
Welding Performance Management System



The AugmentedArc augmented reality welding system allows students and trainees to experience the most realistic multiprocess welding simulation available – and then seamlessly transition to the industry's most complete live arc experience in the LiveArc welding performance management system.

### Delivering unbeatable advantages

- Optimize instructor efficiency
- Deliver real-time feedback
- Reduce overall training time
- Assess weld operator skills and performance
- Minimize material cost
- Enhance job candidate recruiting and screening
- Build a larger, more-skilled welding workforce



## AugmentedArc® Augmented Reality Weld Training

See literature TS/2.0



Available at approved locations!

Lightweight, balanced AR welding helmet with large viewing area provides a realistic augmented reality environment.

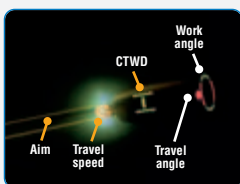
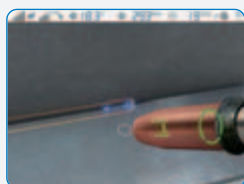

**The highly realistic multiprocess welding simulation solution for classroom training.**

**Optimize instructor efficiency by using the Teacher software** to create a virtual classroom with customized curriculum, quizzes and weld exercises.

**Real-time feedback** is provided on users' technique to help correct errors, reinforce proper welding practices and accelerate skill advancement prior to actual live arc welding in a lab.

**Reduce overall training time.** Compared to traditional methods, AugmentedArc significantly reduces the amount of time needed to teach students.

**Minimize material cost** by saving wire, gas and workpieces in this simulation environment, while allowing students to refine their welding skills before live arc welding.

**Build a larger, more-skilled welding workforce** when computer-savvy individuals are drawn to welding education programs that increase their success.

### AugmentedArc system comes complete with

- AugmentedArc simulator
- Teachers software
- Black Infinity™ AR helmet with premium headgear
- AugmentedArc router
- MIG gun with AR nozzle
- SMAW stinger
- TIG torch with AR nozzle
- Two electrode/filler rods with AR tips
- Work stand for out-of-position applications
- Five workpieces: t-joint, butt joint, lap joint, pipe-to-plate and butt pipe

### Optional components



- **TIG Foot Pedal Kit**  
Includes TIG foot pedal, connection cable and adapter cable
- AugmentedArc Controller  
For multiple system connectivity
- Heavy-duty Transportation Cases  
Protects complete system during transportation or storage – one case holds the simulator and the other holds accessories

Stock Number	Input Power	Voltage/Amperage Selection	Welding Positions	Polarity Selection	Shielding Gas Selection	Wire Speed Selection	Base Material Selection	Workpiece Selection	Stick Electrode Selection	Diameter Selection	Simulator Dimensions	Net Weight
Available at approved locations	115 V, 15 A, 60 Hz	GMAW: 10-38 V, 50-425 A FCAW: 10-38 V, 50-425 A SMAW: 50-425 A GTAW: 50-425 A	1F-4F, 1G-6G	DCEP, DCEN, AC	CO <sub>2</sub> , Argon O <sub>2</sub> , Argon CO <sub>2</sub> , Argon	GMAW/FCAW: 1.27-25.4 m/min. (50-1,000 ipm)	Carbon steel, Stainless steel, Aluminum	3.2, 6.4, 9.5 mm (1/8, 1/4, 3/8 in.)	E7018, E6010, E6013	Solid wire: 0.8, 1.0, 1.2 mm (.030, .035, .045 in.) Stick electrode: 2.5, 3.25, 4.0 mm (1/8, 3/32, 5/32 in.) Filler rod: 2.0, 2.4 mm (5/64, 3/32 in.)	H: 533 mm (21 in.) W: 238 mm (9.38 in.) D: 438 mm (17.25 in.)	Simulator: 9.4 kg (20.7 lb.) Helmet: 0.9 kg (1.97 lb.)

## LiveArc™ Welding Performance Management System

See literature TS/1.0

Available at approved locations!

GMAW/FCAW/SMAW system shown.



**The reality-based recruiting, screening, training, and re-qualification solution for industrial, manufacturing and educational markets.**

**Better and more cost effective training with faster results.** Benefit from both weld simulation and the real-world experience of live arc welding with instant, valuable feedback on welding technique to quickly help build skills.

**Motion-tracking technology** measures the operator's adherence to preset technique parameters. Cameras track the movement of LEDs embedded in the MIG SmartGun and SMAW SmartStinger during pre-weld simulations and live welds; the system then delivers visual feedback on the operator's performance via the LiveArc system's main display.



### LiveArc GMAW/FCAW system comes complete with

- Computer with Intel core i7, 128 GB SSD, fanless cooling, and HDMI port for connection to most secondary monitors (not included)
- 21.5 HD LCD touch screen monitor
- SmartGun with 4.6 m (15 ft.) cable
- Calibration tool
- Two table clamps
- Removable arm extension with C-clamp assembly for out-of-position right- and left-hand applications
- Extra Bernard® consumables

### LiveArc GMAW/FCAW/SMAW system includes above plus

- SmartStinger with 3.7 m (12 ft.) cable
- 4.6 m (15 ft.) Dinse-style cable
- Router box
- Software update for SMAW applications

Stock Number	Input Power	Processes	Positions	Multi-Pass	Rated Output	Electrode Diameter	Dimensions	Net Weight
(907714) GMAW/FCAW system (907714001) GMAW/FCAW/SMAW system	120 V, 60 Hz Compatible with Miller power sources	GMAW, GMAW-S, GMAW-P, FCAW-G SMAW	2F-4F, 1G-4G	Groove and fillet up to 25 mm (1 in.) plate Limited groove applications	SmartGun: 400 A at 60% duty cycle (mixed gases) SmartStinger: 250 A at 60% duty cycle	SmartGun: Up to 2.0 mm (5/64 in.) SmartStinger: Up to 3.2 mm (1/8 in.)	H: 1,969 mm (77.5 in.) W: 1,168 mm (46 in.) D: 787 mm (31 in.)	GMAW/FCAW system: 218 kg (480 lb.) GMAW/FCAW/SMAW system: 239 kg (527 lb.)





**Miller recommends**



**Bernard semi-automatic MIG guns and consumables** have been used and trusted for decades by top companies in agriculture, shipbuilding and fabrication. This is why Miller not only recommends Bernard MIG guns but also pairs these guns with many of their industrial wire feeders and power sources.

For information on Bernard MIG gun options and for detailed technical support information, please visit **BernardWelds.com** or your local distributor to learn more.

Visit the **NEW! merged website** for  
**Bernard and Tregaskiss at Tregaskiss.com**



## **Maximizing throughput. Minimizing costs.**

Automated welding applications require flexible, repeatable solutions that **maximize production uptime and throughput while minimizing costs**. This is why industrial manufacturers rely on Tregaskiss and its proven track record of delivering **reliable and resilient robotic MIG welding guns and peripherals**.



Visit **Tregaskiss.com** for more information or to configure a robotic gun for your welding application today.



## Automated MIG 95

### Cable Connectors and Adapters 95/102

### Carts, Cylinder Racks and Running Gear 95-97

### Coolmate Coolant Systems 96

### Engine Drive Accessories 97-98

- Big Blue Accessories ▪ Blue Star and Fusion Accessories
- Bobcat and Trailblazer Accessories
- Protective Covers ▪ Remote Output Panel Kit ▪ Trailers
- Welder/Generator Accessories

## Load Banks 98

### MIG Accessories 98

- Machine and Gun Accessory Kits ▪ Protective Covers

### Plasma Cutter Accessories 99

- Automation Kits ▪ Cables and Cable Covers
- Cutting Guides ▪ Filters ▪ Plugs and Cords
- Protective Case ▪ Torches

### Process Selector Control/Polarity Switch 100

### Remote Controls and Wireless Remote Controls 100-102

## Stick Accessory Kits 100

### Submerged Arc Accessories 100

- Cables ▪ Torch Accessories
- Wire Drive Assembly Accessories

### TIG Accessories 101-102

- Expansion Memory Card ▪ Kits ▪ Protective Case/Covers
- Remote Controls ▪ Torch and Weld Cable Connectors

### Wire Feeder Accessories 103

- Extension Cables (14-pin) ▪ Power Supply Adapter
- Spool Adapter ▪ Spool Gun Controls and Kits
- Wire Straightener

## Automated MIG

For adapters and drive motors, visit [MillerWelds.com](http://MillerWelds.com).

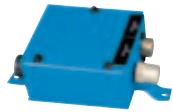

### Coolant Flow Switch 195461

For water-cooled guns. To ensure coolant is flowing in the system. A lack of coolant flow may cause damage to water-cooled guns.

Module allows wiring into the peripheral connector port. 15.2 m (50 ft.) cable with connector and separate shell connector for simple modification to desired length in the field. Quarter-turn quick connection.

## Cable Connectors and Adapters

Also see *Torch and Weld Cable Connectors in TIG Accessories*.

For *AlumaFeed* system, *Invision 352 MPa*, *XMT 350*, *CST*, *Maxstar*, *Dynasty* and *Syncrowave*. These power sources are equipped with Dinse- or Tweco-style connectors for secondary connections. Power sources are shipped with two male plugs for use with #4 to #1/0 AWG cable.

### Dinse-Style Connector Kits

**042418** Accepts #4 to #1/0 AWG cable

**042533** Accepts #1/0 to #2/0 AWG cable

Kits include one male Dinse-style plug which attaches to the work and/or weld cables and plugs into the Dinse-style receptacles on the power source.

### Extension Kit for Dinse-Style Cable Connectors

**042419** Accepts #4 to #1/0 AWG cable

Used to adapt or extend weld and/or work cables. Kit includes one male Dinse-style plug and one in-line female Dinse-style receptacle.

### Extensions for Dinse-Style Cable Connectors

**134460** Male Dinse-style plug

**136600** Female Dinse-style receptacle

Used to adapt or extend weld and/or work cables. Accepts #1/0 to #2/0 AWG cable.



### Tweco®-Style Connector 191981

Accepts #1/0 to #2/0 AWG

cable. Kit includes one Tweco-style male plug which attaches to the work and/or weld cables and plugs into the Tweco-style receptacles on the power source.



### Dinse/Tweco® Adapter 042465 Dinse/Cam-Lok Adapter 042466

One-piece adapter with Dinse-style male plug (to power source) on one end and Tweco or Cam-Lok female receptacle (for weld cable connection) on other end.



### Tweco®/Dinse Adapter 210061

One-piece adapter with Tweco-style male plug (to power source) on one end and Dinse-style female receptacle (for weld cable connection) on other end.

## Carts, Cylinder Racks and Running Gear



### Feeder Cart 142382

A low-profile, creeper cart which allows the operator to easily move the feeder around the work area.



### Universal Cart and Cylinder Rack 042934

For *Invision 352 MPa*, *XMT 350*, *CST*, *Diversion*, *Maxstar 210/280* and *Dynasty 210/280*.

Also accommodates a single gas cylinder up to 1,422 mm (56 in.) high

measuring 152 to 229 mm (6 to 9 in.) in diameter. Provides storage for auxiliary items such as electrodes, helmets and gloves.



### Running Gear/Cylinder Rack 301239

For *Millermatic 141/211*, *Multimatic 200/215* and *Diversion*. Heavy-duty construction with 203 mm (8 in.) rubber rear wheels, convenient front handles, cable holders and plastic consumable box. For gas

cylinders no greater than 178 29.5 kg (65 lb.) in weight.



### Dual Cylinder Rack Cart

Dual Cylinder Rack Conversion Kit and Tool Holder (**301454**) for use with Running Gear/Cylinder Rack above.



### Dual EZ-Change™ Low Cylinder Rack with Elevated Gun and Cable Rack 300337

For *Millermatic 122* *Auto-Set/252* and *Syncrowave 210*. Allows operators to easily roll cylinders on and off the rack with no lifting and keeps cables off the floor and tangle free. Elevated Gun

and Cable Rack (**300335**) is also available separately for use with factory-installed single-cylinder rack.



### EZ-Latch™ Single Cylinder Running Gear 301449

For *Millermatic 255* and *Multimatic 255*. Running gear with a single-cylinder rack and storage compartment. Machine is secured to cart by latches that rotate to disengage machine for easy portability.



### EZ-Latch™ Dual Cylinder Rack Running Gear

EZ-Latch Dual Cylinder Rack with Elevated Gun and Cable Rack (**301481**) for use with EZ-Latch Single Cylinder Running Gear above.



### Dual Cylinder Rack 195299

For *Millermatic 350P/350P Aluminum*. Replaces single-cylinder rack.

# ACCESSORIES



### MIGRunner™ Cart 195445

For AlumaFeed system and XMT 350/400 models with single-wire feeders. Small footprint and easily maneuverable, with a dual-cylinder rack low enough that you do not have to lift bottles. Durable, heavy-duty ergonomic handles are designed for comfort.



### Deltaweld 350/500 Running Gear 301523

For Deltaweld 350/500. Features small footprint, dual-cylinder rack, chains for gas cylinders,

ergonomic handle design, lockable front casters, two torch holders, plus a storage area below.



### 2-Wheel Trolley Cart 300971

For Maxstar 210/280 and Dynasty 210/300 with or without Coolmate 1.3. Easy-to-maneuver two-wheel cart features single-cylinder rack, chain for cylinder, straps (quick and easy to detach and carry machine), cable holders, torch holder, storage area, and filler rod storage area.



### Running Gear Cylinder Rack 300408

For XMT with single- or dual-wire feeders. Holds two large gas cylinders and has gun cable hangers and a consumable drawer in front. A convenient handle allows the cart to be pulled easily through doorways. Power source and single- or dual-wire feeders can be mounted to cart and secured.



### Continuum Running Gear/Cylinder Rack 301264

For Continuum. Small footprint and easily maneuverable, with cylinder rack low enough that you do not have to lift bottles.



### Syncrowave 300/400 4-Wheel Cart 301601

For Syncrowave 300/400 (machine only). Cart includes storage space with latching door, handles, cylinder rack with chain, foot control

holster, and cooler adapter kit. Allows for the addition of a Coolmate 3 externally powered cooler if desired.



### Small Runner™ Cart 301615

For Maxstar 210/280 and Dynasty 210/300 with or without Coolmate 1.3. Cart features single-cylinder rack, foot pedal holder, two cable/torch holders and two TIG filler holders.



### Runner™ Cart 300244

For Maxstar 400/800 and Dynasty 400/800 with or without Coolmate 3.5. Cart features single-cylinder rack, foot pedal holder, three cable/torch holders and two TIG filler holders.

## Coolmate™ Coolant Systems

See literature AY/7.2



Coolmate 1.3

Coolmate 3

Coolmate 3.5

Coolmate 4

### Coolmate 1.3 301616 120 V, CE

For Maxstar 210/280 and Dynasty 210/300. Light industrial, 4.9 L (1.3 gal.) cooler designed for water-cooled torches on power sources rated up to 300 amps\*.

### Coolmate 3 043007 120 V, CE 043008 240 V

Economical, 11.4 L (3 gal.) cooler designed for water-cooled torches rated up to 500 amps\*.

### Coolmate 3.5 300245 120 V, CE

For Maxstar 400/800 and Dynasty 400/800. Industrial, 13.2 L (3.5 gal.) cooler designed for water-cooled torches rated up to 600 amps\*.

### Coolmate 4 042288 120 V

Best performer in its class – industrial, 15 L (4 gal.) cooler designed for water-cooled torches rated up to 600 amps\*.

\*May vary with torch design and cable length. Miller® coolant systems are backed by the best warranty in the industry – one full year.

## Coolant

Must be ordered in quantities of four. One-gallon recyclable plastic bottle. Miller® coolants contain a base of ethylene glycol and deionized water to protect against freezing to -38°C (-37° Fahrenheit) or boiling to 108°C (227° Fahrenheit).



### Low-Conductivity Coolant (clear, pre-mixed) 043810

For TIG and MIG applications. NOT for use in push-pull systems or systems where aluminum is in coolant path/circuit.

### Aluminum-Protecting Coolant (green, pre-mixed) 043809

Primarily used in push-pull systems where aluminum is in coolant path/circuit and high frequency is NOT used.

Model	Motor Input Voltage	Maximum Current Draw	Maximum Cooling Capacity	IEC Cooling Capacity	Tank Capacity	Dimensions	Net Weight
Coolmate 1.3, CE	115 V, 50/60 Hz	5.9 A (50 Hz), 4.7 A (60 Hz)	3,400 W (11,600 Btu/hr.) 3.6 L/min. (3.8 qt./min.)	1,330 W (4,540 Btu/hr.) 1 L/min. (1.1 qt./min.)	4.9 L (1.3 gal.)	H: 289 mm (11.38 in.) W: 264 mm (10.38 in.) D: 616 mm (24.25 in.)	21 kg (46 lb.)
Coolmate 3, CE	115 V, 50/60 Hz	5.9 A (50 Hz), 4.7 A (60 Hz)	3,820 W (13,000 Btu/hr.) 4.0 L/min. (4.2 qt./min.)	1,420 W (4,840 Btu/hr.) 1 L/min. (1.1 qt./min.)	11.4 L (3 gal.)	H: 337 mm (13.25 in.) W: 311 mm (12.25 in.) D: 584 mm (23.25 in.)	18 kg (40 lb.)
	230 V, 50/60 Hz	2.5 A (50 Hz), 3.0 A (60 Hz)					
Coolmate 3.5, CE	115 V, 50/60 Hz	5.9 A (50 Hz), 4.7 A (60 Hz)	4,140 W (14,000 Btu/hr.) 4.7 L/min. (5.0 qt./min.)	1,660 W (5,660 Btu/hr.) 1 L/min. (1.1 qt./min.)	13.2 L (3.5 gal.)	H: 298 mm (11.75 in.) W: 400 mm (15.75 in.) D: 660 mm (26 in.)	29 kg (64 lb.)
Coolmate 4	115 V, 50/60 Hz	5.9 A (50 Hz), 4.7 A (60 Hz)	5,500 W (18,000 Btu/hr.) 5.6 L/min. (5.9 qt./min.)	1,780 W (6,070 Btu/hr.) 1 L/min. (1.1 qt./min.)	15 L (4 gal.)	H: 413 mm (16.25 in.) W: 387 mm (15.25 in.) D: 476 mm (18.75 in.)	17 kg (38 lb.)

## Engine Drive Accessories

Also see Trailers.

### Big Blue Accessories



**Cable Holder 043946**  
For Big Blue 500 Pro/600 Series/  
800 Series.



**Vandalism Lockout Kit 399802 Field**  
For Big Blue 500 Pro/600 Series.  
Lockable hinged steel panels cover  
and protect name plate gauges and  
ignition switch (padlock included).  
Also includes engine compartment  
door lock and key.

### Blue Star and Fusion Accessories



**Lifting Eye 195353**  
For Fusion and Blue Star.



**Running Gear 301246**  
For Fusion and Blue Star.  
Compact and balanced,  
lightweight wheelbarrow-style  
running gear provides easy  
on-site mobility.

### Bobcat and Trailblazer Accessories



**Multi-Terrain  
Running Gear with  
Never Flat™ Tires**

**301460** For Bobcat 200 Air Pak.

**301708** For gas/LP Bobcat and gas Trailblazer  
(except Air Pak models).

**301717** For Trailblazer 330 Diesel.

Includes two heavy-duty 381 mm (15 in.) tires, two  
203 mm (8 in.) rubber swivel casters and a heavy-duty  
handle. Recommended for all surfaces and applications  
and is easy to move around the jobsite.



**Off-Road  
Running Gear with  
Never Flat™ Tires**  
**301706**

For gas/LP Bobcat and gas Trailblazer (except Air Pak  
models). Includes four heavy-duty 381 mm (15 in.) tires  
and a rugged handle to provide maximum maneuverability.



**Off-Road  
Running Gear  
with Protective Cage  
and Never Flat™ Tires**  
**301707**

For gas/LP Bobcat and gas Trailblazer (except Air Pak models).  
Running gear and rugged cage with cable holders protects  
your investment and is easy to move around the jobsite.



**Protective Cage  
with Cable Holders**

**301709** For gas/LP Bobcat and gas Trailblazer  
(except Air Pak models).

**301718** For Trailblazer 330 Diesel.

Rugged cage with cable holders protects your investment.  
Works with Running Gear, Gas Cylinder Mounting Assembly  
or LP Tank Mounting Assembly.



**Gas Cylinder  
Mounting Assembly**  
**301711**

For gas Bobcat and Trailblazer (except Air Pak models).  
Designed for use with Running Gear, Protective Cage,  
or by itself. Includes base tray with bottle bracket, vertical  
support rack and safety chain.  
*Note: Not for use with LP Tank Mounting Assembly.  
Not recommended for use with Protective Cover.*



**Hose and LP Tank  
Mounting Assembly**  
**301710**

For LP Bobcat. Designed for use with Running Gear,  
Protective Cage, or by itself. Includes bracket and clamp  
to mount 15 and 19.5 kg (33 and 43 lb.) tanks  
horizontally, and hose with fittings to converter.

*Note: Not for use with Gas Cylinder Mounting Assembly.  
Not recommended for use with Protective Cover.*

## Protective Covers



Protective covers (301712) and (195301) shown.

### Protective Covers

Heavy-duty, water- and mildew-resistant covers protect  
and maintain the finish of the welder.

**301245** For Fusion and Blue Star.

**301475** For gas Bobcat 200 Air Pak  
**without** Running Gear.

**301476** For gas Bobcat 200 Air Pak **with** Running Gear.

**301531** For diesel Bobcat 200 Air Pak  
**without** Running Gear.

**301532** For diesel Bobcat 200 Air Pak  
**with** Running Gear.

**301712** For gas Bobcat and Trailblazer (except Air Paks)  
**without** Protective Cage or Running Gear.

**301713** For gas Bobcat and Trailblazer (except Air Paks)  
**with** Protective Cage or Running Gear.

**301731** For diesel Trailblazer 330  
**without** Protective Cage or Running Gear.

**301729** For diesel Trailblazer 330 **with** Protective Cage  
or Running Gear.

**301730** For Trailblazer 330 Air Pak.

**195301** For Big Blue 400 Pro/400 PipePro/  
450 Duo CST.

**301495** For Big Blue 500 Pro/600 Pro with Kubota.

**301113** For Big Blue 600 Air Pak/  
800 Series with Deutz.

## Welder/Generator Accessories



**Twist Lock Adapter Cord**  
**301489**

For Fusion. L14-30R to  
NEMA 6-50R. Adapts  
engine drive 120/240-volt  
twist lock plug to common  
Millermatic and Spectrum  
240-volt plug.



**Female  
Receptacle**

**Full KVA Adapter Cord 300517**

For Bobcat, Trailblazer and Big Blue models.  
NEMA 14-50P to NEMA 6-50R. Adapts engine drive  
120/240-volt plug to common Millermatic and  
Spectrum 240-volt plug.



**Full KVA Plug Kit**

**119172** 1-phase, 120/240 V,  
50 A plug (NEMA 14-50P). For Bobcat,  
Trailblazer and Big Blue models.  
**165963** 3-phase, 480 V, 30 A plug  
(NEMA L16-30P). For Bobcat 230 3 Phase.  
**254140** 3-phase, 240 V, 50 A plug  
(NEMA 15-50P). For Big Blue 500 Pro/  
600 Series/800 Series.





# ACCESSORIES

## Trailers

See literature AY/20.0



### HWY-Mid Frame Trailer 301438

For Bobcat, Trailblazer and Big Blue 400 Pro/400 PipePro/450 Duo CST. A 646 kg (1,424 lb.) capacity highway trailer with welded steel tubing frame, heavy-duty axle with roller bearing hubs and leaf-spring suspension. Includes jack stand, fenders, lights, and dual hitch with 50 mm (2 in.) ball hitch and 76 mm (3 in.) lunette eye.



### HWY-225 Trailer 301338

For Big Blue models. A 1,225 kg (2,700 lb.) capacity highway trailer with welded steel tubing frame, heavy-duty axle with roller bearing hubs and leaf-spring suspension. Includes jack stand, fenders, lights, and dual hitch with 50 mm (2 in.) ball hitch and 76 mm (3 in.) lunette eye.

Note: Trailers are shipped unassembled. \*Width at outside of fenders.

## Trailer accessories

### Fender Kit 301439

For HWY-Mid Frame and HWY-225. Replacement fenders.

### Dual Hitch 301441

For HWY-Mid Frame and HWY-225. Combination 50 mm (2 in.) ball hitch and 76 mm (3 in.) lunette eye in one reversible assembly.



### Cable Tree 043826

For HWY-Mid Frame and HWY-225. Provides an area to conveniently wrap weld cables and extension cords.



### 2-In-1 Document/Fire Extinguisher Holder 301236

For HWY-Mid Frame and HWY-225. Stores documents and holds a 2.3 kg (5 lb.) fire extinguisher.

Note: Holder shown mounted on trailer. Fire extinguisher not included.



Model	Gross Axle Weight Rating	Gross Vehicle Weight Rating	Net Payload	Height of Bed	Road Clearance	Track (Center to Center of tires)	Standard Tires (Standard Rating or P-size Rating)	Dimensions	Net Weight
HWY-Mid Frame	728 kg (1,605 lb.)	646 kg (1,424 lb.)	646 kg (1,424 lb.)	495 mm (19.5 in.)	203 mm (8 in.)	1,168 mm (46 in.)	ST175/80D-13 Load Range C	L: 2,565 mm (101 in.) W: 1,397 mm (55 in.)*	82 kg (181 lb.)
HWY-225	1,588 kg (3,500 lb.)	1,360 kg (2,999 lb.)	1,225 kg (2,700 lb.)	483 mm (19 in.)	191 mm (7.5 in.)	1,270 mm (50 in.)	ST175/80R-13 Load Range D	L: 2,680 mm (105.5 in.) W: 1,435 mm (56.5 in.)*	127 kg (280 lb.)

## Load Banks



### LBP-350 043329

Designed to provide an adjustable load for troubleshooting or calibrating welding power sources or engine-driven welders. Standard

equipment includes analog meters for both AC and DC output with jacks for external metering connections. It comes with a 4 m (13 ft.) 115-volt power cord and has seven 50-amp load switches, providing a maximum capacity of 350 amps.

## MIG Accessories

### Machine and Gun Accessory Kits



MIG kit with Dinse-style connectors for single-wire feeders shown.

### Industrial MIG 4/0 Kit (with lugs)

**300390** For single-wire feeders.

**300957** For dual-wire feeders.

Consists of flowmeter regulator with 3 m (10 ft.) gas hose, 3 m (10 ft.) 4/0 feeder weld cable with lugs, and 4.6 m (15 ft.) work cable with 600-amp C-clamp. Dual kit comes with two flowmeter regulators and gas hoses.

### Industrial MIG 4/0 Kit (with Dinse-style connectors)

**300405** For single-wire feeders.

**300956** For dual-wire feeders.

Same as above except weld and work cables have Dinse-style connector on one end instead of lug.

### MIGmatic™ M-Series Gun Consumable Kits

**234607** 0.6 m (.023 in.) wire

**234608** 0.8 m (.030 in.) wire

**234609** 0.9 m (.035 in.) wire

For M-100/M-150 guns. Kits include ten contact tips, one tip adapter, one standard nozzle and a consumable storage box.

## Protective Covers



### 301737

For Millermatic 142. Features side pocket.



### 301262

For Millermatic 211 and Multimatic 215. Features side pocket.



### 301524

For Multimatic 220 AC/DC.



### 301521

For Millermatic 255 and Multimatic 235/255. Features side pocket.



### 195142

For Millermatic 252 and Syncrowave 210. Features side pocket.

## Plasma Cutter Accessories

### Automation Kits



Spectrum 875 Auto-Line automation kit shown.

**Automation Kits for Spectrum 875 and 875 Auto-Line 301156** For Spectrum 875.

**301157** For Spectrum 875 Auto-Line.

Upgrades hand-held torch packages to add machine torch capabilities. Automation kit for Spectrum 875 Auto-Line (**301157**) includes a remote pendant control for manual on/off. Machine torches are NOT included in kits and must be ordered separately.

### Cables and Cable Covers



#### Flexible Work Cable

**234838** 6.1 m (20 ft.)

**234930** 15.2 m (50 ft.)

Work cable with quick connect and heavy-duty clamp.



#### Cable Covers

**239642** 6.1 m (20 ft.)

**231867** 7.6 m (25 ft.)

**231868** 15.2 m (50 ft.)

### Cutting Guides

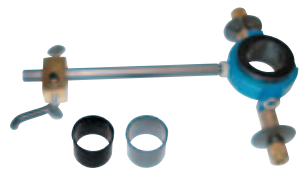

#### Plasma Circle-Cutting Guides 253055

For XT30/XT40/XT60 torches. Cut straight lines or circles up to 305 mm (12 in.) in diameter.

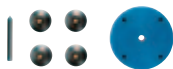

#### Suction/Magnetic Pivot Base 195979

Add this to your cutting guide for convenient attachment to all flat surfaces. The extended arm accommodates holes up to 762 mm (30 in.) in diameter.



#### Plasma Standoff Roller Guide 253054

Helps maintain recommended standoff distance to maximize cutting performance and improve tip life.

### Filters



#### In-Line Air Filter Kit 228926

For Spectrum 375 X-TREME/625 X-TREME/875/875 Auto-Line. Mounts to back of the plasma cutter. Includes male and female 6.4 mm (1/4 in.) NPT quick-disconnect fittings and hose for easy on/off connection. The replaceable filter element (**228928**) filters to .85 microns for removal of 99.9 percent of water, dirt and oil.



#### RTI Filter and Bracket 300491

For Spectrum 875/875 Auto-Line. Dryer will remove water, dirt and oil as small as one micron with 99.9 percent efficiency. Can be mounted on plasma cutter or on wall. Install as close as possible to point of air consumption. Replaceable filter element (**212771**).

### Plugs and Cords

#### MVP™ Plugs



#### 219258

For 6-50P power cable (230/240 V, 50 A).



#### 219261

For 5-15P power cable (115/120 V, 15 A).



#### 219259

For 5-20P power cable (115/120 V, 20 A).

For Spectrum 375 X-TREME, Millermatic 211, Multimatic 200/215/220 AC/DC, Thunderbolt 160, Diversions, Syncrowave 210 and Fusion. Allows connection of machine to 115/120-volt or 230/240-volt receptacles without tools – just choose the plug that fits the receptacle.

#### MVP™ Adapters



Female Receptacle



#### 254328

For connection to 6-50P receptacle (240 V, 50 A).



#### 254330

For connection to 5-15P receptacle (120 V, 15 A).



#### 254331

For connection to 5-20P receptacle (120 V, 20 A).

For Spectrum 625 X-TREME. Allows connection of machine to 120- or 240-volt receptacles without tools – just choose the adapter cord that fits the receptacle.



Female Receptacle

#### Full KVA Adapter Cord 300517

NEMA 14-50P to NEMA 6-50R. Adapts engine drive 120/240-volt plug to common Millermatic and Spectrum 240-volt plug.

#### 230-Volt Extension Cord 770644

6.1 m (20 ft.) NEMA 6-50P to NEMA 6-50R heavy-duty extension cord. 8-gauge cord has lighted ends that show power is on and a molded integrated strain relief.

### Protective Case



#### X-CASE 300184

For Spectrum 375 X-TREME/625 X-TREME.

### Torches

See your Miller® distributor for complete information on the following XT plasma torches and their consumables:



#### Spectrum Plasma Cutter Hand-Held Torches

##### For Spectrum 375 X-TREME

**249949** 3.7 m (12 ft.) XT30

##### For Spectrum 625 X-TREME

**260633** 3.7 m (12 ft.) XT40

**260635** 6.1 m (20 ft.) XT40

##### For Spectrum 875 and 875 Auto-Line

**249953** 6.1 m (20 ft.) XT60

**249954** 15.2 m (50 ft.) XT60

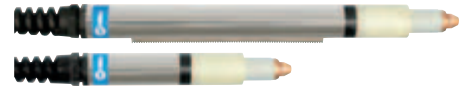

#### Spectrum 875 and 875 Auto-Line Plasma Cutter Machine Torches

**249955** 7.6 m (25 ft.) long body XT60M

**249956** 15.2 m (50 ft.) long body XT60M

**257464** 7.6 m (25 ft.) short body XT60M

**263952** 15.2 m (50 ft.) short body XT60M



Each consumable kit includes a storage box.

#### Plasma Torch Consumable Kits

**253520** For XT30 torch. Includes five electrodes, five tips, one swirl ring, one retaining cup, one o-ring and silicone grease.

**253521** For XT40 torch. Includes five electrodes, five 40-amp tips, three 30-amp tips, one 40-amp drag shield, two 30-amp drag shields, one deflector, one o-ring, one swirl ring, one retaining cup, one 40-amp gouge tip, one gouge shield and silicone grease.

**256033** For XT60 torch. Includes three standard electrodes, three standard tips, one drag shield, one deflector, one o-ring, one swirl ring, one retaining cup, one gouge tip, one gouge shield and silicone grease.

**127493** Empty consumable storage box.

## Polarity Switches/Controls

### Polarity Control 042871

This dual-function control is designed for use with dual wire feeders or any application where electrical isolation and/or polarity reversing of weld current is required. Both functions can be used at the same time.



### Process Selector Control 042872

For CC, CV or CC/CV welding power source. Provides easy way to change welding process. Also includes features of Polarity Control.

## Remote Controls

Also see Remote Controls in TIG Accessories.



### PRHC-14 Hand Control 195511

For all solid-state power sources after serial number JK674521. Complete current or voltage control brings 120 volts of GFCI power to work area in a single cord. Housed in a durable and light aluminum case and includes 38 m (125 ft.) cord with plugs.

## Stick Accessory Kits



### No. 2 Stick Cable Sets

**195196** 4.6 m (15 ft.)

**300836** 15 m (50 ft.)

Consists of either 4.6 or 15.2 m electrode cable with holder and work cable with clamp. 200 A, 100% duty cycle.



### 2/0 Stick Cable Sets

**173851** 15.2 m (50 ft.), 350 A

**043952** 30/15 m (100/50 ft.), 300 A

Consists of either 15.2 or 30 m 2/0 electrode cable with holder and 5.2 m work cable with clamp. 100% duty cycle.



### Weld Cables

**195457** 2/0 cable with electrode holder, 400 A

**195458** 2/0 cable with work clamp, 400 A

**301387** 1/0 cable with electrode holder, 250 A

Consists of a stud/Tweco® adapter and 3 m (10 ft.) weld cable with a Tweco male connector and either an electrode holder or work clamp.



### 2/0 Weld Cable Extensions

**195456** 15.2 m (50 ft.)

**195455** 30 m (100 ft.)

Extends weld cables

(**195457**, **195458** and **301387**).

## Submerged Arc Accessories

### Cables



### SubArc Control Cables

**260622030** 9.1 m (30 ft.)

**260622050** 15 m (50 ft.)

**260622060** 18.3 m (60 ft.)

**260622080** 24.4 m (80 ft.)

**260622100** 30.5 m (100 ft.)

**260622120** 36.6 m (120 ft.)

**260622200** 61.0 m (200 ft.)

Cable between SubArc Interface or Motor Control and power source.



### Flux Hopper Extension Cables

**260623010** 3 m (10 ft.)

**260623025** 7.6 m (25 ft.)

**260623065** 19.8 m (65 ft.)

Cable between SubArc Interface or Motor Control and flux hopper.



### Motor Extension Cables

**254232005** 1.5 m (5 ft.)

**254232010** 3 m (10 ft.)

**254232025** 7.6 m (25 ft.)

**254232065** 19.8 m (65 ft.)

Cable between SubArc Interface or Motor Control and drive motor.



### Continuum Motor/Control Cables

**263368015** 4.6 m (15 ft.)

**263368025** 7.6 m (25 ft.)

**263368050** 15.2 m (50 ft.)

**263368080** 24.4 m (80 ft.)

**263368100** 30.5 m (100 ft.)

Cable between SubArc Motor Control and SubArc Remote Pendant.



### SubArc Parallel Cable

**260775015** 4.6 m (15 ft.)



### SubArc Tandem Cable

**260878015** 4.6 m (15 ft.)

## Torch Accessories

### OBT 600 Torch Body Extensions

**043967** 25.4 mm (1 inch)

**043969** 50.8 mm (2 inch)

**043973** 101.6 mm (4 inch)

**043975** 152.4 mm (6 inch)

### OBT 1200 Torch Body Extension 043981

Overall length with extension is 228.6 mm (9 inches).

Actual length of extension is 215.9 mm (8.5 inches).

### OBT Torch Contact Tips

OBT 600	OBT 1200	Wire Size
<b>192700</b>	<b>192141</b>	1.6 mm (1/16 in.)
<b>192701</b>	<b>199026</b>	2.0 mm (5/64 in.)
<b>192702</b>	<b>192142</b>	2.4 mm (3/32 in.)
<b>192703</b>	<b>200771</b>	2.8 mm (7/64 in.)
<b>192704</b>	<b>192143</b>	3.2 mm (1/8 in.)
<b>192705</b>	<b>192144</b>	4.0 mm (5/32 in.)

### 1200-Amp Twin-Wire Torch Contact Tips

**264595** 1.2 mm (3/64 in.)

**264596** 1.6 mm (1/16 in.)

**264597** 2.0 mm (5/64 in.)

**264588** 2.4 mm (3/32 in.)

## Wire Drive Assembly Accessories

### Drive Rolls

**132955** 1.6 mm (1/16 in.)

**132960** 2.0 mm (5/64 in.)

**132961** 2.4 mm (3/32 in.)

**132962** 2.8 mm (7/64 in.)

**132963** 3.2 mm (1/8 in.)

**193700** 4.0 mm (5/32 in.)



### Single-Wire Straightener 199733

For OBT 600 and OBT 1200 single-wire torches. For 1.6–4.8 mm (1/16–3/16 inch) wire.



### Twin-Wire Straightener 301160

For 1200-amp twin-wire torch only. Single adjustment.



### Manual Single Slide 301137

Provides smooth and accurate movement of the welding heads. Allows for 200 mm (7.87 inch) travel adjustment with load capacity of 100 kg (220 pounds) at 500 mm (1.64 feet). **Not recommended for tandem.**



### Wire Reel 108008

Supports 27 kg (60 lb.) coil of wire. Requires Spool Support Assembly (**119438**).



## TIG Accessories

### Expansion Memory Card

#### QuietPulse™ Expansion Memory Card 301790

For Maxstar 210/280/280 Multiprocess/400/800 manufactured prior to serial number ND040985L. Gain the ability to utilize QuietPulse when DC pulsed TIG welding. QuietPulse is activated by changing the waveshape for DC pulse welding to create a slower, more fluid transition between the background and peak amperage, resulting in lower audible noise.

### Kits



A-200 torch with RCCS-14 kit shown.

#### Contractor Kit

**301309** A-150 torch with RFCS-14 HD foot pedal  
**301311** A-150 torch with RCCS-14 fingertip  
**301549** A-200 torch with RFCS-14 HD foot pedal  
**301550** A-200 torch with RCCS-14 fingertip  
 For Maxstar 210/280 and Dynasty 210/300. All-in-one TIG/stick welding kit comes with either a Weldcraft™ A-150 OR A-200 TIG torch, RFCS-14 HD foot control OR RCCS-14 fingertip control, 200-amp stick electrode holder and 300-amp work clamp with 4.6 m (15 ft.) cables, flow gauge regulator with 3.7 m (12 ft.) gas hose, gas hose coupler, AK2C torch accessory kit, and TIG torch connector.



#### TIG Contractor Kit 301337

For Multimatic 215. Kit comes with Weldcraft™ A-150 TIG torch with Dinse-style connector, RFCS-RJ45 foot control, flow gauge

regulator with 3.7 m (12 ft.) gas hose, and AK2C torch accessory kit.



#### Multimatic 235/255 TIG Kit 301518

Kit comes with 7.6 m (25 ft.) Weldcraft™ A-150 TIG torch with Dinse-style connector, RFCS-14 HD foot control, 10-pin

to 14-pin adapter cord, flow gauge regulator with 1.5 m (5 ft.) gas hose, and AK3C torch accessory kit.



W-280 torch kit shown.

#### Weldcraft™ Water-Cooled Torch Kits

**300185** 250 A, W-250 (WP-20)  
**300990** 280 A, W-280 (WP-280)  
**301268** 375 A, W-375  
**300186** 400 A, W-400 (WP-18SC)

For Syncrowave 300/400, Maxstar (except 161 models) and Dynasty. Kit comes with 7.6 m (25 ft.) TIG torch with Dinse-style connector (thread-lock on 400-amp kit), torch cable cover, work clamp with 4.6 m (15 ft.) cable [3.7 m (12 ft.) cable on 400-amp kit], flowmeter regulator with gas hose, and AK4GL gas lens accessory kit (AK18C accessory kit on 400-amp kit).

## Protective Case/Covers



#### X-CASE 301429

For Maxstar 161 models.

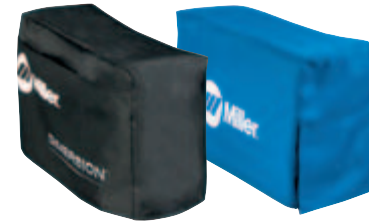

Protective covers (300579) and (301382) shown.

**300579** For Diversion.

**195142** For Syncrowave 210.

**301381** For Maxstar 210.

**301382** For Maxstar 280 and Dynasty 210/300.

## Remote Controls



#### 14-Pin to 6-Pin Adapter Cord 300507

For Maxstar 161 STL/STH. 305 mm (12 in.) cord adapts Miller® 14-pin foot control or fingertip control to a 6-pin plug.



#### 10-Pin to 14-Pin Adapter Cord 301545

For Multimatic 235/255. Allows standard 14-pin

TIG remote controls to be used with the Multimatic 235 and Multimatic 255.



**RCC-14** (14-pin plug)

**151086** 8 m (26.5 ft.) cord with plug

**RCC-6M** (6-pin plug)

**301118** 4 m (13.25 ft.) cord with plug

For Maxstar 161 STL/STH.

East/west rotary-motion fingertip current/contacter control attaches to TIG torch using two hook-and-loop fasteners. Great for production or contractors that need quick ramp-up.



**RCCS-14** (14-pin plug)

**043688** 8 m (26.5 ft.) cord with plug

**RCCS-6M** (6-pin plug)

**195184** 4 m (13.25 ft.) cord with plug

**195503** 8 m (26.5 ft.) cord with plug

For Maxstar 161 STL/STH.

**RCCS-RJ45**

**301146** 4 m (13.25 ft.) cord with plug

For Multimatic 215 and Diversion.

North/south rotary-motion fingertip current/contacter control attaches to TIG torch using two hook-and-loop fasteners. Great for applications that require a finer amperage control.



**RFCS-14 HD** (14-pin plug)

**301589** 6 m (20 ft.) cord with plug

**RFCS-6M HD** (6-pin plug)

**301587** 4 m (13.25 ft.) cord with plug

**301588** 6 m (20 ft.) cord with plug

For Maxstar 161 STL/STH.

Heavy-duty foot pedal current/contacter control provides increased stability and durability from larger base and heavier cord.



**RFCS-RJ45 300432**

For Multimatic 215 and Diversion. Foot pedal current/contacter control. Includes 4.3 m (14 ft.) cord with plug.



**RHC-14** (14-pin plug)

**242211020** 6 m (20 ft.) cord with plug

**242211100** 30.5 m (100 ft.) cord with plug

Miniature hand current/contacter control.

Dimensions: 102 x 102 x 82 mm (4 x 4 x 3.25 inches).



**RMLS-14** (14-pin plug) **129337**

Momentary- and maintained-contact rocker switch for contactor control. Push forward for maintained contact and backward for momentary contact. Includes 8 m (26.5 ft.) cord with plug.



**RMS-6M** (6-pin plug) **195269**

For Maxstar 161 STL/STH.

**RMS-14** (14-pin plug) **187208**

Momentary-contact switch for contactor control. Rubber-covered pushbutton dome switch ideal for repetitive on-off applications. Includes 8 m (26.5 ft.) cord with plug.



**RPBS-14** (14-pin plug) **300666**

Attaches to the TIG torch to remotely start and stop the TIG welding process. Includes 7.6 m (25 ft.) cord with plug.



## Wireless Remote Foot and Hand Controls

See literature AY/6.5 (Foot) and AY/6.6 (Hand)

**Increases productivity, saves money, improves safety and is easy to use.**



Wireless 14-pin receiver (included with both systems)

Wireless foot control

Wireless hand control

**Bluetooth® communication technology** provides consistent and reliable connection, allowing precise control of the amperage.

**Improves productivity and maneuverability** by eliminating cord tangles. Reduces clean up time and work area cord clutter.

**Improves reliability and safety** by eliminating control cord failures and reducing potential trip hazard.

**Multiple frequency sharing** allows up to 20 systems to operate in a 27.4 m (90 ft.) radius with accuracy and precision – and without delay, system interference, or crosstalk.

**Easy-to-install receiver** plugs directly into the 14-pin receptacle of Miller® machines.

**Easily programmable.** Control can be quickly and easily paired with any other Miller® 14-pin wireless receiver. Control is preprogrammed when purchased with the receiver.

### Foot control

**Foot control is designed specifically for TIG welding** in manufacturing, fabrication and plant applications, allowing operator to adjust amperage at point of use without the limitations of a remote cord.

**Auto on** feature extends the battery life up to 250 hours of welding without turning the pedal on and off.

**Easy-Glide Wear Pads™** glide across concrete, making it easy to reposition the pedal for comfort and speed.

### Hand control

**Hand control is designed for stick, TIG, MIG and flux-cored welding**, allowing operator to adjust parameters for different joint configurations, electrodes and wire types/sizes at the point of use instead of walking back to the machine.

**Allows parameter adjustments up to 91 m (300 ft.) away from welder** without returning to machine.

**Improves weld quality.** Operators can adjust their machines to optimize the parameters for different joint configurations, electrodes, and wire types and sizes.

**Smart Touch™ buttons** allow quick and accurate machine parameter adjustments.

**Digital meter display** allows presetting percentage of machine output before welding, and viewing of amperage and voltage while welding.

*\*Some applications are not suitable for wireless communication. Keep in mind that the rated range is subjective, and depends on factors such as obstructions, frequency interference, transmission technology, and weather. The figures listed assume ideal conditions are present.*

Model/Stock Number	Component	Power Supply	Battery Life	Rated Range*	Temperature	Radio Frequency	RF Power	Antenna	Dimensions	Weight
Wireless Foot Control System (301580), CE	Foot control (transmitter)	Three AA batteries	250 hours	27.4 m (90 ft.)	-25° to +70°C (-13° to +158°F)	2.4 Ghz (ISM band)	<3 mW	Internal	H: 152 mm (6 in.) W: 146 mm (5.75 in.) D: 292 mm (11.5 in.)	1.4 kg (3 lb.) w/batteries
Wireless Hand Control System (301582), CE	Hand control (transmitter)	Three AA batteries	250 hours	91 m (300 ft.)					H: 127 mm (5 in.) W: 70 mm (2.75 in.) D: 35 mm (1.375 in.)	0.27 kg (0.6 lb.) w/batteries

### Industrial

#### Processes

- TIG (GTAW) ▪ Pulsed TIG (GTAW-P)
- Stick (SMAW)<sup>1</sup> ▪ MIG (GMAW)<sup>1,2</sup>
- Flux-cored (FCAW)<sup>1,2</sup>

<sup>1</sup>With wireless hand control only.

<sup>2</sup>Only with voltage-sensing feeder.

#### Comes complete with

- Wireless foot control (301580) **OR** hand control (301582) transmitter
- Wireless 14-pin receiver (301584)
- Four AA batteries
- Four Easy-Glide Wear Pads™ (foot control only – sold individually, 248274)
- Carabiner clip (hand control only, 285341)

#### Suggested power sources



Look throughout this catalog for the icon above signifying compatibility with a wireless remote.

## TIG Accessories (continued)

### Torch and Weld Cable Connectors

#### Air-Cooled TIG (GTAW) Torch Connectors



**273483<sup>1,2</sup>**

For Multimatic 200/215/220 and Maxstar 161.

25 mm (small) Dinse-style gas thru for one-piece air-cooled torches.



**194723** A-200 (WP26)

**194722<sup>2</sup>** All others

For Syncrowave 210.

50 mm Dinse-style gas thru for one-piece air-cooled torches.



**195379** A-200 (WP26)

**195378<sup>2</sup>** All others

For Multimatic 235/255, CST, Syncrowave 300/400, Maxstar 210/280/400, and Dynasty 210/280/400.

50 mm Dinse-style for one-piece air-cooled torches.

#### Water-Cooled TIG (GTAW) Torch Connectors



**50 mm Dinse-Style Flow Thru 195380**

For Syncrowave 210. Used with all Weldcraft™ water-cooled torches.



**50 mm Dinse-Style with Water Return Line 195377**

For Syncrowave 300/400, Maxstar 210/280/400 and Dynasty 210/280/400. Used with all Weldcraft™ water-cooled torches.



**50 mm Thread-Lock-Style 225028**

For Maxstar/Dynasty 800. Used with all Weldcraft™ water-cooled torches.



**Thread-Lock-Style Weld Cable Connectors 225029**

For Maxstar/Dynasty 800. Contains two male connectors that accept #1/0 to #4/0 AWG size cable.

<sup>1</sup>Except A-200 (WP26) torches. <sup>2</sup>A-80 (WP24) torches require 24-5 adapter.



## Wire Feeder Accessories

### Extension Cables (14-Pin)

#### 8-Conductor Cables

- 242208025** 7.6 m (25 ft.)
- 242208050** 15.2 m (50 ft.)
- 242208080** 24.4 m (80 ft.)

For SuitCase 12RC feeder, 20 Series feeders, and 70 Series (except MPa Plus) feeders. For 14-pin remote controls and 24 VAC wire feeders. 14-pin plug to a 14-pin socket. Not for 115-volt XR feeders.

#### 11-Conductor Cables

- 247831025** 7.6 m (25 ft.)
- 247831050** 15.2 m (50 ft.)
- 247831080** 24.4 m (80 ft.)

For XR-AlumaFeed and MPa Plus feeders. Eleven conductors to support contactor control and remote voltage control on all Miller® electronic constant-voltage (CV) 14-pin power sources. Additional functions supported when using the Invision MPa or XMT MPa power sources include synergic pulsed MIG, remote process select and side select capabilities.

#### 14-Conductor Cables

- 242205025** 7.6 m (25 ft.)
- 242205050** 15.2 m (50 ft.)

For HDC and WC-115 weld controls. Fully-loaded 14-pin extension cables for remote controls, and 24-volt and 115-volt feeders.

### Euro Gun Adapter

**164902**

## Power Supply Adapter



### PSA-2 Control 141604

Required when using SuitCase 12RC, 20 Series, and 70 Series feeders with power sources having only 115-volt power available. Control is equipped with a 14-pin receptacle and a 3 m (10 ft.) interconnecting cord with Hubbell connections

for older-style power sources. Can also be used with competitive power sources requiring a contact closure for contactor control.

### PSA-2 Extension Cord 047813

7.6 m (25 ft.) cord extends 3 m (10 ft.) cord supplied with PSA-2 control (4-pin to 4-pin connection).

## Spool Adapter

### 047141

For use with 6.4 kg (14 lb.) spool of Hobart or Lincoln self-shielding wire.



### WC-115A Weld Control 137546

Without contactor **137546011** With contactor Operates on 115-volt power and designed primarily for constant-current DC power sources. Can also be used with

constant-voltage (CV) power sources or DC engine drives supplying 115 volts. Used with a constant-current (CC) source the control circuit functions in a voltage-sensing mode, and with a CV source it functions as a constant-speed circuit. Includes wire run-in and drive motor acceleration controls which ensure optimum arc starting performance.



### WC-24 Weld Control 137549

For Spoolmate 200, Spoolmatic and Spoolmatic Pro. Easily mounts on power source. Designed for use with Miller® constant-voltage (CV) power sources with 14-pin receptacles and supplying 24 VAC.

## Spool Gun Extension Hose and Cable Kits

- 132228** 7.6 m (25 ft.)
- 132229** 15.2 m (50 ft.)

For Spoolmate 200, Spoolmatic and Spoolmatic Pro. Extends leads, etc. between spool gun and power source.

## Wire Straightener



For 20 Series and 74 MPa Plus.

- 141580** For 0.9–1.1 mm (.035–.045 inch) wire.
- 141581** For 1.6–3.2 mm (1/16–1/8 inch) wire.

# For All Your Industrial MIG Gun and Consumable Needs

We've merged our catalogs and our websites to provide one source for all your semi-automatic, robotic, and fixed automatic MIG welding gun and consumable needs.

Visit us online today at **Tregaskiss.com** to access product information, use our online product configurators and learn how to get more out of your welding applications. While you're there you can **request a hard copy of the latest Bernard and Tregaskiss MIG Welding Guns and Consumables catalog** or **sign up for Amperage**, our electronic newsletter.



**Tregaskiss.com**





**International Headquarters**  
Miller Electric Mfg. LLC  
1635 West Spencer Street  
Appleton, Wisconsin 54914, U.S.A.  
International Dept.  
E-mail:  
international@millerwelds.com

**ITW Welding Products Group (FZE)-UAE**  
Phone: +971-4-255-91-94  
E-mail: contact.me@itw welding.com  
Website: https://me.itw welding.com

**ITW Welding Singapore**  
Phone: +65-6552-1223  
E-mail: sgoffice@millerwelds.com  
Website: https://sea.itw welding.com

**Beijing Miller Electric Mfg. LLC**  
Phone: +86-10-8739-7080  
E-mail: sales@millerchina.com  
Website: www.millerchina.com

**Welding Products Group – Latin America**  
Phone: 920-735-4554  
E-mail:  
international@millerwelds.com

**ITW Welding – Brasil**  
Phone: +55-11-3090-3623  
E-mail: contato@millerwelds.com  
Website: www.millerweldsbrasil.com

**ITW India Pvt Limited**  
Phone: +91-75-7580-4663  
E-mail: fredric.prabu@millerwelds.com

**ITW Welding Products – España**  
Phone: +34-96-393-5398  
E-mail: sales.es@itw welding.com  
Website: www.millerweldseurope.com

**ITW Welding Products – Mexico**  
Phone: +52-55-5366-7373  
E-mail: ventas@itw welding.com  
Website: www.millerweldslatam.com

**Welding Industries of Australia**  
Phone: +61-1300-300-884  
E-mail: info@welding.com.au  
Website: www.welding.com.au

**Weldwell New Zealand**  
Phone: +61-0800-9353-9355  
E-mail: info@weldwell.co.nz  
Website: www.weldwell.co.nz















**ITW Welding SAS – France**  
Phone: +33-1-6004-1166  
E-mail: sales.fr@itw welding.com  
Website: www.millerweldseurope.com

**ITW Welding S.R.L. – Italy**  
Phone: 0039-02-982901  
E-mail: sales.it@itw welding.com  
Website: www.millerweldseurope.com

**ITW Welding Products – Nordic**  
Phone: +46-31-726-4600  
E-mail: sales.se@itw welding.com  
Website: www.millerweldseurope.com

**Orbitalum Tools GmbH – Miller Europe**  
Phone: +49-7731-792400  
E-mail: Sales.Miller@itw welding.com

## CONTENTS

<b>INTRO</b>	<b>New from Blue 3</b>
	<b>MIG (GMAW) 4</b>
	<b>Wire Feeders 13</b>
	<b>MIG Guns 20</b>
	<b>Multiprocess 25</b>
	<b>Stick (SMAW) 38</b>
	<b>TIG (GTAW) 42</b>
	<b>Welding Intelligence™ 59</b>
	<b>Engine-Driven Welder/Generators 62</b>
	<b>Submerged Arc 75</b>
	<b>Induction Heating 79</b>
	<b>Plasma Cutters 82</b>
	<b>Safety and Health 84</b>
	<b>Workstations 91</b>
	<b>Training Solutions 92</b>
	<b>Accessories 95</b>

## Index New! or Improved! products appear in blue type.

AlumaFeed Welding System.....8	Fusion 185 .....62	Spoolmatic Spool Guns .....23
ArcReach 16 Feeder.....16	Insight Centerpoint .....61	SubArc Components .....76
ArcReach Heater.....81	Insight Core .....60	SubArc Digital Series .....75
ArcReach Smart Feeder.....15	Intellx Feeders and Swingarc.....10	SubArc Portable Welding System....78
ArcReach Stick/TIG Remotes.....65	LiveArc System.....93	SubArc 3-Wheel Tractor .....77
ArcReach SuitCase Feeders.....15	Maxstar 161 S.....38	SuitCase 12RC Feeder .....15
ArcStation 30FX.....91	Maxstar 161 STL/STH .....43	Syncrowave 210 .....44
ArcStation 60SX .....91	Maxstar 210/280 Series.....46	Syncrowave 300/400.....45
AugmentedArc System.....93	Maxstar 210 STR.....39	20 Series Bench Feeders.....17
Auto-Continuum Systems.....12	Maxstar 280 Multiprocess .....29	Thunderbolt 210 .....38
Big Blue 400X Pro.....70	Maxstar 400 .....48	<b>Trailblazer 330 Series</b> .....68-69
<b>Big Blue 450 Duo CST</b> .....73	MDX Series MIG Guns .....21	<b>Trailblazer 330 Air Pak</b> .....70
Big Blue 500X CC/600X CC.....72	MIGmatic M-Series MIG Guns .....20	Trailers.....98
Big Blue 500X Pro.....71	<b>Millermatic 142/211</b> .....4	Weldcraft Series TIG Torches .....50
Big Blue 700X Duo Pro .....73	Millermatic 252 .....5	Welding Safety and Health .....84
Big Blue 800X Duo Air Pak .....74	Millermatic 255 .....6	Apparel/Jackets .....90
Blue Star 185.....62	Millermatic 355 .....7	Face Shields.....89
<b>Bobcat Series</b> .....66-67	Multimatic 215.....25	Gloves .....89
Bobcat 200 Air Pak.....64	Multimatic 220 AC/DC.....26	<b>Helmets</b> .....86-87
Continuum Systems.....11	Multimatic 235.....27	Helmet Accessories .....88
Coolmate Coolant Systems.....96	Multimatic 255.....28	Respiratory .....84-85
CST 282 .....40	PipeWorx 400 Welding System.....35	Safety Glasses.....88
CST 282 Racks.....40	ProHeat Induction Heating.....79-80	Weld-Mask .....88
Deltaweld Systems.....9	74 MPa Plus Bench Feeders.....17-18	Wireless Remote Controls.....102
Diversion 180 .....43	74 MPa Plus Remote Configurations.....19	XMT 350 FieldPro Systems.....32
Dynasty 210/300 Series.....47	Spectrum Series.....82-83	XMT 450 CC/CV ArcReach .....33
Dynasty 300 Multiprocess .....29	Spoolmate Spool Guns.....22	XMT 650 Series .....34
Dynasty 400/800.....48		XMT Series .....30-31
		XR Push-Pull Guns.....24

